

TRASFORMABILI



W.E.B. DUBOIS

TRANSFORMAZIONE

TRASIFORMAZIONE

W.E.B. DUBOIS



PASSIONE,
SVILUPPO E
INNOVAZIONE

PASSION,
DEVELOPMENT
AND INNOVATION

“Siamo da sempre impegnati nel trovare soluzioni innovative per un vivere moderno, al passo con i nuovi spazi abitativi. Un arredo dinamico capace di soddisfare i bisogni delle persone nel corso della giornata.

Tutto ciò che facciamo deriva dalla nostra passione per l'innovazione.

Quando ho pensato la linea dei Trasformabili, volevo realizzare un sistema magico per trasformare una madia in un pratico e solido tavolo.

È nato così, grazie alla collaborazione con l'Arch. Giulio Manzoni, il primo sistema Trasformabile, l'apripista di un successo continuo”.

“We have always been engaged in finding innovative solutions for the modern life in order to anticipate the demands of new living spaces.

Crisp interior design able to satisfy people's requirements every day.

Everything we do derives from our passion for innovation.

When I was thinking about the Trasformabili line, I wanted to create a magic system, which would be able to convert a counter into a practical

and solid table. This way, thanks to the cooperation with Architect Giulio Manzoni, the first Trasformabili system was born: the forerunner of a continuous success”.

Stefano Del Prete, CEO of Atim Spa

INDICE GENERALE

GENERAL INDEX

SENZA GAMBA WITHOUT LEG

SIESTA

Tavolo da cassetto estraibile
Pull-out drawer table 10

BRUNCH

Tavolo da cassetto estraibile
Pull-out drawer table 12

COCKTAIL

Tavolo da cassetto estraibile
Pull-out drawer table 14

LUNCH

Tavolo da cassetto estraibile
Pull-out drawer table 16

LUNCH REVERSE

Tavolo da cassetto estraibile
Pull-out drawer table 18

SHOT

Piano da cassetto estraibile
Pull-out drawer worktop 20

DESK

Scrivania abbattibile a ribalta
Drop-leaf foldaway desk 22

OPLÀ

Piano estraibile filo ripiano
Pull-out top aligned with shelf 24

OPLÀ FOLDING

Piano estraibile filo ripiano
Pull-out top aligned with shelf 26

HOMEWORK

Tavolo abbattibile a soffietto
Fold-out table 28

COOK

Tavolo da cassetto estraibile con vano
Pull-out drawer table with space 30

FUNCTIONAL

Tavolo da cassetto estraibile con vano
Pull-out drawer table with space 32

BASKET K

Paniere con piano estraibile
Pull-out bread bag with top 34

ZIP

Tavolo da cassetto estraibile
con sistema sincrono:
aperto/chiuso blocco/sblocco
Pull-out drawer table with synchronous
system:
open/close lock/unlock 36

READY

Tavolo da cassetto estraibile con
sistema sincrono: aperto/chiuso
Pull-out drawer table with synchronous
system: open/close 38

1 GAMBA 1 LEG

T-TABLE T-TABLE XL

Tavolo da cassetto estraibile con gamba
singola abbattibile telescopica
Pull-out drawer table with single
telescopic folding leg 40

JUST

Piano a ribalta con gamba
singola abbattibile telescopica
Tilting top with single
telescopic folding leg 42

T-BENCH T-BENCH XL

Seduta da cassetto estraibile
con gamba singola abbattibile
Pull-out drawer bench with
single folding leg 44

2 GAMBE 2 LEGS

PARTY

Tavolo da cassetto estraibile con gamba
doppia abbattibile telescopica
Pull-out drawer table with double
telescopic folding leg 46

EVOLUTION EVOLUTION XL

Tavolo da cabinet estraibile con gamba
a ponte
Pull-out cabinet table with bridge leg 50

MENSOLA PARTY

Tavolo da cassetto estraibile con gamba
doppia abbattibile telescopica
Pull-out drawer table with double
telescopic folding leg 48

TOP

OPLÀ TOP

Piano estraibile filo top
Pull-out top aligned with counter top 52

SANDWICH

Top estraibile con easybook
Pull-out top with easybook 54

FLIP TOP

Piano da cassetto estraibile con
easybook
Pull-out drawer worktop with
easybook 56

BREAKFAST

Piano estraibile
Pull-out top 58

BREAKFAST TOP

Piano scorrevole su top
Sliding table top 60

SLIDE

Piano scorrevole su top
Sliding table top 62

SNACK

Piano scorrevole
Sliding table top 64

SNACK TOP

Piano scorrevole su top
Sliding table top 66

FLAP

Piano scorrevole su top
Sliding table top 68

CORNER

Piano scorrevole su top
Sliding table top 70

TWICE

Piano scorrevole
Sliding top 72

TWICE TOP

Piano scorrevole su top
Sliding table top 74

TOP33

Piano scorrevole su top
Sliding table top 76

PENISOLA PENINSULA

VOILÀ VOILÀ FLAG

Piano estraibile con gambe
Pull-out top table with legs 78

VOILÀ CHAIR

Piano estraibile con gambe
Pull-out top table with legs 80

VOILÀ CHAIR REVERSE

Piano estraibile con gambe
Pull-out top table with legs 82

DINAMICO DINAMICO+

Piano scorrevole
Sliding table top 84

SESTANTE

Piano scorrevole e girevole
su top con gambe
Sliding and revolving
table top with legs 86

+39

EVOLUTION +39 EVOLUTION XL +39

Tavolo da cabinet estraibile
con gamba a ponte
Pull-out cabinet table
with bridge leg 88

HOMEWORK +39

Tavolo abbattibile a soffietto
Fold-out table 90

LUNCH +39

Tavolo da cassetto estraibile
Pull-out drawer table 92

MENSOLA T-ABLE +39

Tavolo da cassetto estraibile con gamba
singola abbattibile telescopica
Pull-out drawer table with single
telescopic folding leg 94

OPLÀ +39

Piano estraibile filo ripiano
Pull-out top flush with shelf 96

OPLÀ FOLDING +39

Piano estraibile filo ripiano
Pull-out top flush with shelf 98

T-BENCH +39

Seduta da cassetto estraibile
con gamba singola abbattibile
Pull-out bench with single
folding leg 100

SHOT +39

Piano da cassetto estraibile
Pull-out drawer worktop 102

BAGNO BATHROOM

PRUA PRUA SHORT

Asse da stiro estraibile
Pull-out ironing board 104

PRUA LIFT

Asse da stiro a ribalta
Tilting ironing board 106

PRUA SWING

Asse da stiro rotante
Revolving pull-out ironing board 108

BASKET

Sacco lavanderia
con piano estraibile
Pull-out laundry bag with top 110

OPTIONAL

2.8016912.06

Cerniera spessore
Hinge thickness
16/22 mm

Da ordinare nel numero necessario al prodotto
To be ordered in the number necessary for the product



2.8029912.12

Cerniera spessore
Hinge thickness
16/22 mm

Da ordinare nel numero necessario al prodotto
To be ordered in the number necessary for the product

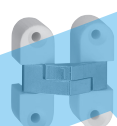

2.8048168.06

Cerniera spessore
Hinge thickness
18/30 mm

Da ordinare nel numero necessario al prodotto
To be ordered in the number necessary for the product

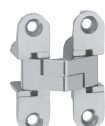

CORNICE STICK STICK FRAME

Cornice in alluminio verniciata. Finitura: nero opaco RAL 9005
Painted aluminum frame. Finish: matt black RAL 9005



PIANO BIANCO WHITE TOP

Piano truciolare melaminico bianco con bordato ABS 10/10
Codice di riferimento nella pagina del prodotto. I piani, se necessario, sono forniti di cerniere e viti
Top white chipboard with ABS
Reference code on the product page. The tops, if necessary, are supplied with hinges and screw

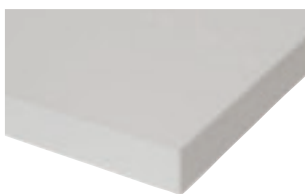

PIANO INOX INOX TOP

Piano multistrato rivestito in acciaio AISI A430
Codice di riferimento nella pagina del prodotto
Plywood top covered in AISI A430 steel
Reference code on the product page

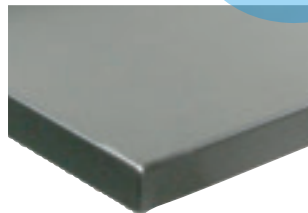

TAPPI STICK STICK CAPS

Tappi in ABS grigio per frontale profilo.
Codice di riferimento nella pagina del prodotto
Gray ABS caps for front profile.
Reference code on the product page



COVER DESK

Tappi in ABS per copertura meccanismo
Codice di riferimento nella pagina del prodotto
ABS caps for mechanical coverage
Reference code on the product page



PERSONALIZZAZIONI

Tutta la serie dei nostri Trasformabili è personalizzabile in funzione delle esigenze del cliente. Dimensioni, forature, aperture, packaging e gestione, sono alcuni degli aspetti che rendono i nostri prodotti compatibili e complementari con i vostri mobili al 100%.

PERSONALIZATION

All our Trasformabili series is customizable, depending on our clients' needs. Dimensions, drilling, opening and packaging are only some of the aspects that make our products 100% compatible and complementary to your furniture.

SERIE SILENT

In una continua ricerca di soluzioni e migliorie, il nostro reparto R&S ha studiato ed industrializzato, per tutta la famiglia dei Trasformabili, la versione SILENT. Soluzione che conferisce ai nostri sistemi una silenziosità assoluta. Disponibile su richiesta.

SILENT SERIES

In a constant search for improvements, our R&D department has studied and industrialized the Silent Series for all the Trasformabili collection. The solution guarantees a substantial noise reduction in all systems. Available on request.

ATIM ONLINE

Seguici online per rimanere sempre aggiornato su tutte le nostre novità di prodotto, gli eventi, innovazioni e molto altro.

E iscriviti alla nostra **newsletter**: niente spam, solo informazioni accuratamente selezionate per te e il tuo business.

Siamo anche sui **principali canali social e portali dedicati all'architettura, all'arredamento e al design**.

Sfoglia i nostri progetti, aggiungi i nostri prodotti al tuo ideabook e interagisci direttamente con noi!

Follow us online to stay up to date on all the news about our products, events, innovations and much more.

Sign up to our **newsletter**: no spam, only information carefully selected for you and your business.

We are also on the main **social media channels and portals dedicated to architecture, furniture and design**.

Discover our projects, add our products to your ideabook and interact directly with us!



**ATTRAVERSO QUESTO QR CODE
VERRAI INDIRIZZATO AI VIDEO DEI
NOSTRI MECCANISMI SU YOUTUBE,
UTILISSIMI ANCHE DURANTE IL
MONTAGGIO.**



**USE THIS QR CODE TO WATCH
THE TUTORIAL VIDEOS OF OUR
MECHANISMS ON YOUTUBE,
TO HELP YOU ALSO DURING
THEIR ASSEMBLY.**

GARANZIA DELLA MASSIMA QUALITÀ HIGHEST QUALITY GUARANTEED



I TRASFORMABILI ATIM VENGONO SOTTOPOSTI ALLE PROVE CATAS, CHE VALUTANO LA SICUREZZA, RESISTENZA E DURATA DEI PRODOTTI IN ACCORDO ALLE NORME TECNICHE NAZIONALI, EUROPEE E INTERNAZIONALI.

ATIM'S TRASFORMABILI ARE TESTED BY CATAS, WHICH ASSESSES THE SAFETY, STRENGTH AND DURABILITY OF THE PRODUCTS IN ACCORDANCE WITH ITALIAN, EUROPEAN AND INTERNATIONAL TECHNICAL STANDARDS.

atim[®]
ALUMINIUM TECHNOLOGY



TRASFORMABILI



Siesta

TAVOLO DA CASSETTO ESTRAIBILE
PULL-OUT DRAWER TABLE

DESIGN

Arch. Giulio Manzoni
ATIM R&S / ATIM R&D

FINITURA FINISHING

Anodizzato naturale (Grigio satinato)
Anodised aluminium (Gray satin)

PORTATA LOAD CAPACITY

80 Kg equamente distribuiti
80 Kg evenly distributed

PACKAGING

118x18x8 cm
5 Kg
0,017 m³

SCORRIMENTO SLIDING

Cuscinetti a sfera
Ball-bearing slide system

OPTIONAL

su richiesta on request

KIT TAPPI KIT CAPS

2.9250551.XX

CERNIERE HINGES

2.8016912.06
2.8029912.12
2.8048168.06



NOTE
L'articolo non prevede la fornitura delle parti in legno.
The item does not include the supply of wooden parts.

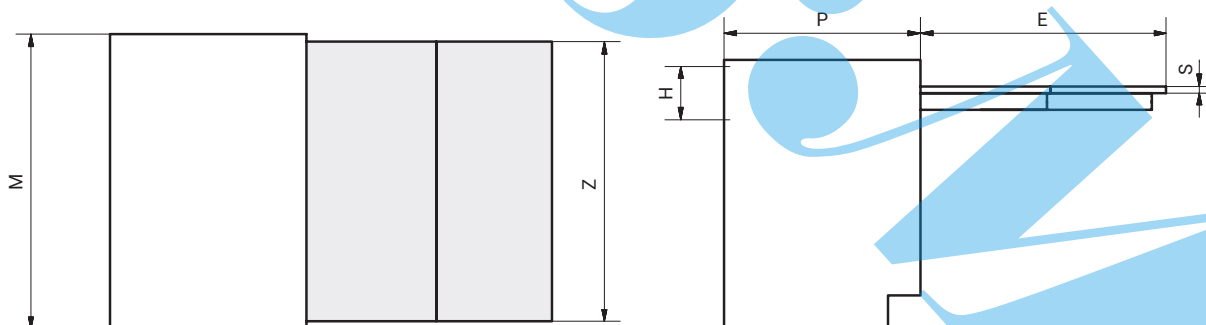

CODICE CODE	M	P MIN	H MIN.	S1	E	Z MIN	S MIN
411/78.1155.22	450	550	120	15/20	750	405	16
411/78.1150.22	600	550	120	15/20	750	555	16
411/78.1160.22	900	550	120	15/20	750	855	16
411/78.1170.22	1200	550	120	15/20	750	1155	16

Valori espressi in millimetri. Value expressed in millimetres.

Legenda tabella a pagina 112. Table key on page 112.



Brunch

TAVOLO DA CASSETTO ESTRAIBILE
PULL-OUT DRAWER TABLE

DESIGN

Arch. Giulio Manzoni
ATIM R&S / ATIM R&D

FINITURA FINISHING

Anodizzato naturale (Grigio satinato)
Anodised aluminium (Gray satin)

PORTATA LOAD CAPACITY

80 Kg equamente distribuiti
80 Kg evenly distributed

PACKAGING

118x18x8 cm
8,5 Kg
0,017 m³

SCORRIMENTO SLIDING

Cuscinetti a sfera
Ball-bearing slide system

OPTIONAL

su richiesta on request

KIT TAPPI KIT CAPS

2.9250571.XX

CERNIERE HINGES

2.8016912.06
2.8029912.12
2.8048168.06



NOTE
L'articolo non prevede la fornitura delle parti in legno.
The item does not include the supply of wooden parts

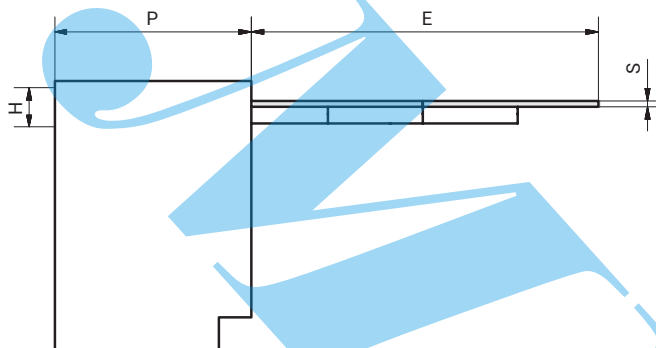
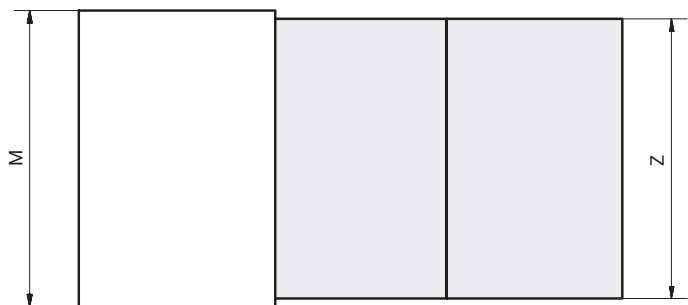

CODICE CODE	M	P MIN	H MIN.	S1	E	Z MIN	S MIN
411/78.1100.22	600	540	120	15/20	1060	555	16
411/78.1110.22	900	540	120	15/20	1060	855	16
411/78.1120.22	1200	540	120	15/20	1060	1155	16

Valori espressi in millimetri. Value expressed in millimetres.

Legenda tabella a pagina 112. Table key on page 112.



Cocktail

TAVOLO DA CASSETTO ESTRAIBILE
PULL-OUT DRAWER TABLE

FINITURA FINISHING

Inox Bronzino

PORTATA LOAD CAPACITY

60 Kg equamente distribuiti
60 Kg evenly distributed

PACKAGING

118x18x8 cm
3,8 Kg
0,017 m³

SCORRIMENTO SLIDING

Alluminio / Alluminio
Aluminium / Aluminium

OPTIONAL

su richiesta on request

KIT TAPPI KIT CAPS

2.9247221.XX

CERNIERE HINGES

2.8016912.06

2.8029912.12

2.8048168.06

DESIGN

Arch. Giulio Manzoni
ATIM R&S / ATIM R&D

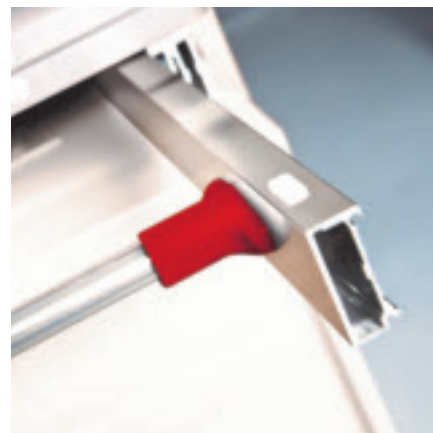

NOTE
L'articolo non prevede la fornitura delle parti in legno.
The item does not include the supply of wooden parts

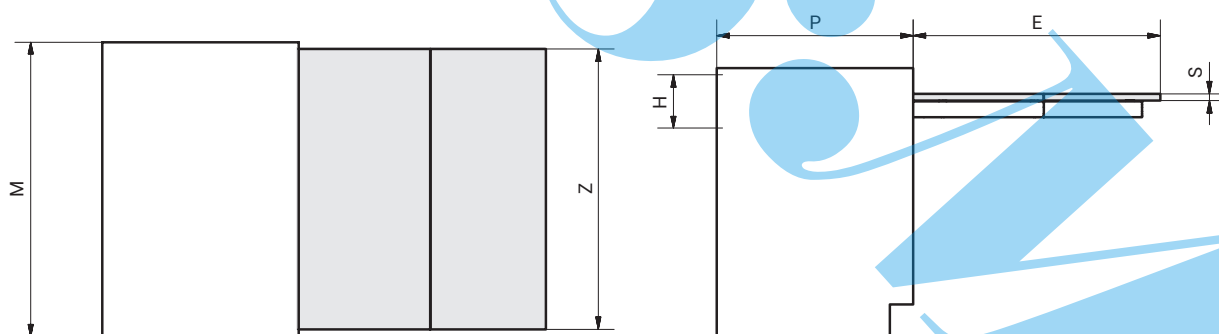

CODICE CODE	M	P MIN	H MIN.	S1	E	Z MIN	S MIN	SILENT
411/78.1155.22 E	450	540	120	15/20	753	405	16	78.1155.22 E
411/78.1150.22 E	600	540	120	15/20	753	555	16	78.1150.22 E
411/78.1160.22 E	900	540	120	15/20	753	855	16	78.1160.22 E
411/78.1170.22 E	1200	540	120	15/20	753	1155	16	78.1170.22 E

Valori espressi in millimetri. Value expressed in millimetres.

Legenda tabella a pagina 112. Table key on page 112.



Lunch

TAVOLO DA CASSETTO ESTRAIBILE
PULL-OUT DRAWER TABLE

FINITURA FINISHING

Inox Bronzino

PORTATA LOAD CAPACITY

60 Kg equamente distribuiti
60 Kg evenly distributed

PACKAGING

118x18x8 cm
5 Kg
0,017 m³

SCORRIMENTO SLIDING

Alluminio / Alluminio
Aluminium / Aluminium

OPTIONAL

su richiesta on request

KIT TAPPI KIT CAPS

2.9247231.XX

PIANO TOP TABLE

Truciolare bianco
White chipboard

Lunch 450 3.9132836.12 M

Lunch 600 3.9129876.12 M

Lunch 900 3.9129866.12 M

CERNIERE HINGES

2.8016912.06

2.8029912.12

2.8048168.06

DESIGN

Arch. Giulio Manzoni
ATIM R&S / ATIM R&D

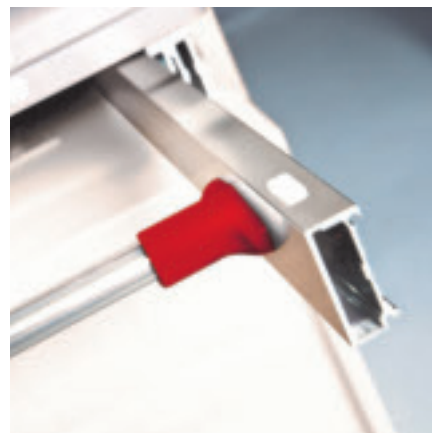

NOTE
L'articolo non prevede la fornitura delle parti in legno.
The item does not include the supply of wooden parts

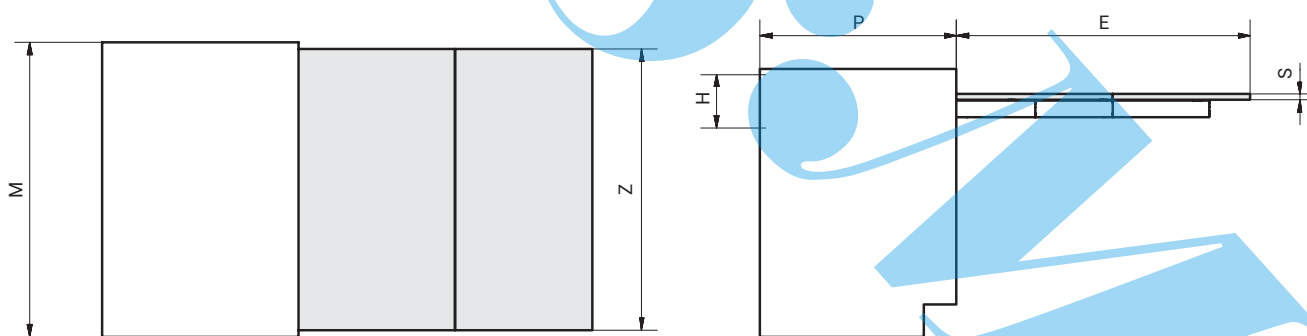

CODICE CODE	M	P MIN	H MIN	S1	E	Z MIN	S MIN	SILENT
411/78.1105.22 E	450	540	120	15/20	895	405	16	78.1105.22 E
411/78.1100.22 E	600	540	120	15/20	895	555	16	78.1100.22 E
411/78.1110.22 E	900	540	120	15/20	895	855	16	78.1110.22 E
411/78.1120.22 E	1200	540	120	15/20	895	1155	16	78.1120.22 E

Valori espressi in millimetri. Value expressed in millimetres.

Legenda tabella a pagina 112. Table key on page 112.



Lunch Reverse

TAVOLO DA CASSETTO ESTRAIBILE
PULL-OUT DRAWER TABLE

DESIGN

Arch. Giulio Manzoni
ATIM R&S / ATIM R&D

FINITURA FINISHING

Inox Bronzino

PORTATA LOAD CAPACITY

60 Kg equamente distribuiti
60 Kg evenly distributed

PACKAGING

118x18x8 cm
4,5 Kg
0,017 m³

SCORRIMENTO SLIDING

Alluminio / Alluminio
Aluminium / Aluminium

OPTIONAL

su richiesta on request

KIT TAPPI KIT CAPS

2.9247231.XX

CERNIERE HINGES

2.8016912.06
2.8029912.12
2.8048168.06

NOTE

L'articolo non prevede la fornitura delle parti in legno.
The item does not include the supply of wooden parts

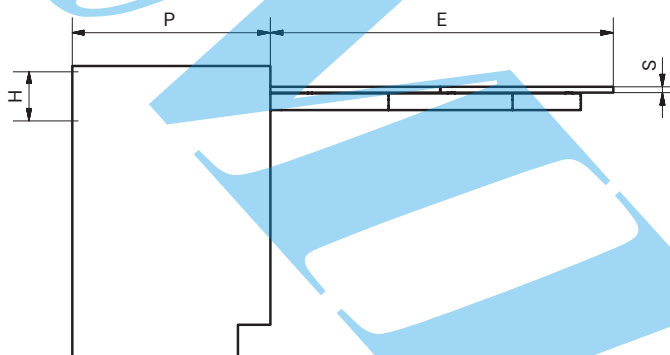
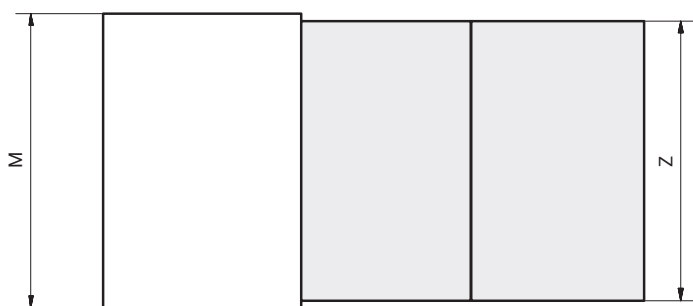

CODICE CODE	M	P MIN	H MIN	S1	E	Z MIN	S MIN	SILENT
411/78.1100.25 R	450/1200	540	120	15/20	1045	405/1155	16	78.1100.25 R

Valori espressi in millimetri. Value expressed in millimetres.

Legenda tabella a pagina 112. Table key on page 112.



Shot

PIANO DA CASSETTO ESTRAIBILE
PULL-OUT DRAWER WORKTOP

DESIGN

Arch. Giulio Manzoni
ATIM R&S / ATIM R&D

FINITURA FINISHING

Inox Bronzino

PORTATA LOAD CAPACITY

80 Kg equamente distribuiti
80 Kg evenly distributed

PACKAGING

118x18x8 cm
4 Kg
0,017 m³

SCORRIMENTO SLIDING

Alluminio / Alluminio
Aluminium / Aluminium

OPTIONAL

su richiesta on request

KIT TAPPI KIT CAPS

2.9247221.XX

NOTE

L'articolo non prevede la fornitura delle parti in legno.
The item does not include the supply of wooden parts

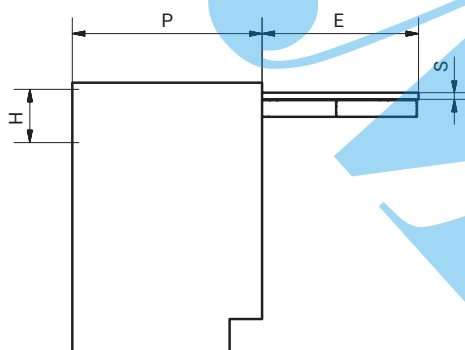
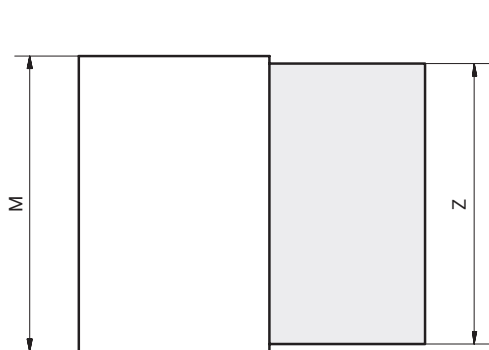

CODICE CODE	M	P MIN	H MIN	S1	E	Z	S MIN	SILENT
411/78.1130.25	450/1200	560	90	15/20	490	405/1155	16	78.1130.25
411/78.1130.25 F	450/1200	560	90	15/20	490	405/1155	16	78.1130.25 F

Valori espressi in millimetri. Value expressed in millimetres.

Legenda tabella a pagina 112. Table key on page 112.



Desk

SCRIVANIA ABBATTIBILE A RIBALTA
DROP-LEAF FOLDAWAY DESK

DESIGN

Arch. Giulio Manzoni
ATIM R&S / ATIM R&D

FINITURA FINISHING

Ferro zincato / Galvanised iron - .02
Acciaio inox / Stainless steel - .05

PORTATA LOAD CAPACITY

20 Kg equamente distribuiti
20 Kg evenly distributed

PACKAGING

35x18x6
3,1 Kg
0,003 m³

OPTIONAL

su richiesta on request

COVER

Nero
Black
2.5541204.10

Bianco
White
2.5541204.12

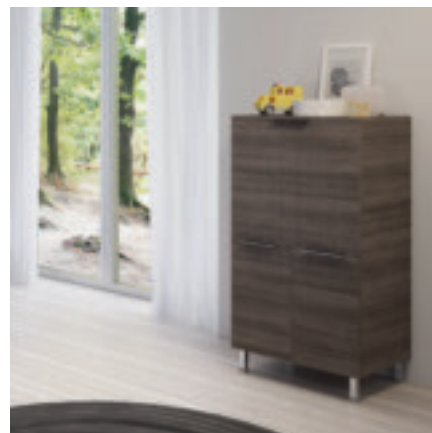

NOTE
L'articolo non prevede la fornitura delle parti in legno.
The item does not include the supply of wooden parts.

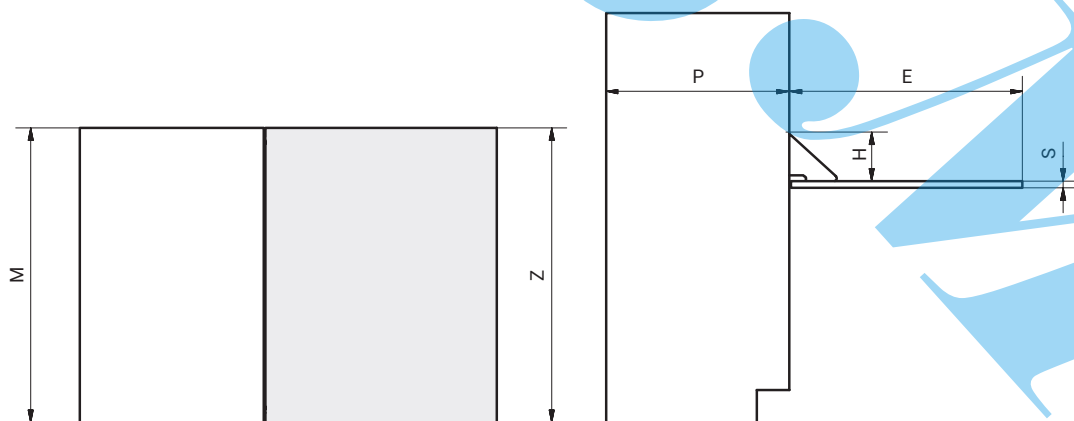

CODICE CODE	M MIN	P MIN	H MIN	S1	E MIN	Z MIN	S MIN
411/78.0005.02	450	150	200	15/20	350	445	18
411/78.0005.06	450	150	200	15/20	350	445	18

Valori espressi in millimetri. Value expressed in millimetres.

Legenda tabella a pagina 112. Table key on page 112.



Oplà

PIANO ESTRAIBILE FILO RIPIANO
PULL-OUT TOP ALLIGNED WITH SHELF

DESIGN

Arch. Giulio Manzoni
ATIM R&S / ATIM R&D

FINITURA FINISHING

Inox Bronzino

PORTATA LOAD CAPACITY

40 Kg equamente distribuiti
40 Kg evenly distributed

PACKAGING

118x18x8 cm
4,4 Kg
0,017 m³

SCORRIMENTO SLIDING

Alluminio / Alluminium
Aluminium / Aluminium

OPTIONAL

su richiesta on request

KIT TAPPI KIT CAPS

2.9247221.XX

PIANO IN ACCIAIO STAINLESS TOP TABLE

Oplà 600
411/78.1700.AC

Oplà 900
411/78.1710.AC

Oplà 1200
411/78.1720.AC

PACKAGING

Oplà 600
57x51x16 cm
10 Kg
0,05 m³

Oplà 900
87x51x16 cm
11 Kg
0,07 m³

Oplà 1200
117x51x16 cm
12 Kg
0,09 m³

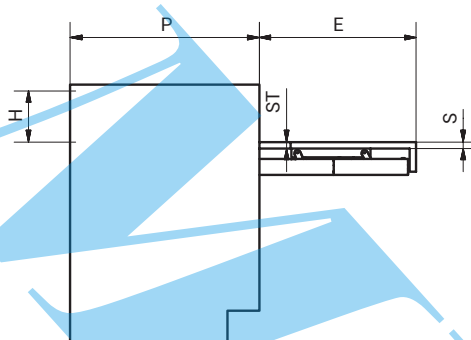
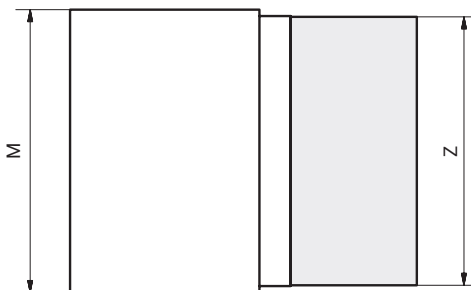

NOTE
L'articolo non prevede la fornitura delle parti in legno.
The item does not include the supply of wooden parts.

CODICE CODE	M	P MIN	H MIN	S1	E	Z MIN	S	ST	SILENT
411/78.1700.22	450	540	75	15/20	500	405	15/20	15/20	78.1700.22
411/78.1710.22	600	540	75	15/20	500	555	15/20	15/20	78.1710.22
411/78.1720.22	900	540	75	15/20	500	855	15/20	15/20	78.1720.22
411/78.1730.22	1200	540	75	15/20	500	1155	15/20	15/20	78.1730.22

Valori espressi in millimetri. Value expressed in millimetres.

Legenda tabella a pagina 112. Table key on page 112.



Oplà Folding

PIANO ESTRAIBILE FILO RIPIANO
PULL-OUT TOP ALLIGNED WITH SHELF

DESIGN

Arch. Giulio Manzoni
ATIM R&S / ATIM R&D

FINITURA FINISHING

Inox Bronzino

PORTATA LOAD CAPACITY

40 Kg equamente distribuiti
40 Kg evenly distributed

PACKAGING

118x18x8 cm
7 Kg
0,017 m³

SCORRIMENTO SLIDING

Alluminio / Alluminio
Aluminium / Aluminium

OPTIONAL

su richiesta on request

KIT TAPPI KIT CAPS

2.9247221.XX

NOTE

L'articolo non prevede la fornitura delle parti in legno.
The item does not include the supply of wooden parts.

L'articolo è fornito solo nella versione Silent
The item is supplied only Silent version

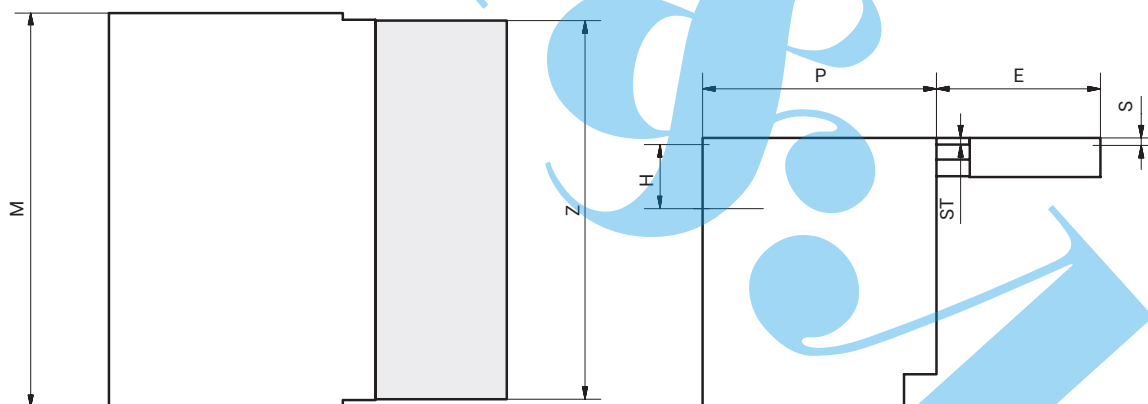

CODICE CODE	M	P MIN	H MIN	S1	E	Z MIN	S	ST
78.1700.25 F	600	540	220	18	500	555	18	15/35
78.1710.25 F	900	540	220	18	500	855	18	15/35
78.1720.25 F	1200	540	220	18	500	1155	18	15/35
78.1700.25 FS	600	540	125	18	500	550	18	15/35
78.1710.25 FS	900	540	125	18	500	850	18	15/35
78.1720.25 FS	1200	540	125	18	500	1150	18	15/35

Valori espressi in millimetri. Value expressed in millimetres.

Legenda tabella a pagina 112. Table key on page 112.



Homework

TAVOLO ABBATTIBILE A SOFFIETTO
FOLD-OUT TABLE

FINITURA FINISHING

Inox Bronzino

PORTATA LOAD CAPACITY

40 Kg equamente distribuiti
40 Kg evenly distributed

PACKAGING

118x18x8 cm
4,5 Kg
0,017 m³

SCORRIMENTO SLIDING

Alluminio / Alluminio
Aluminium / Aluminium

OPTIONAL

su richiesta on request

KIT TAPPI KIT CAPS

2.9247231.XX

KIT HOMEWORK

Cerniere + Blumotion
Hinges + Blumotion

2.9248320.XX

DESIGN

Arch. Giulio Manzoni
ATIM R&S / ATIM R&D



NOTE
L'articolo non prevede la fornitura delle parti in legno.
The item does not include the supply of wooden parts.

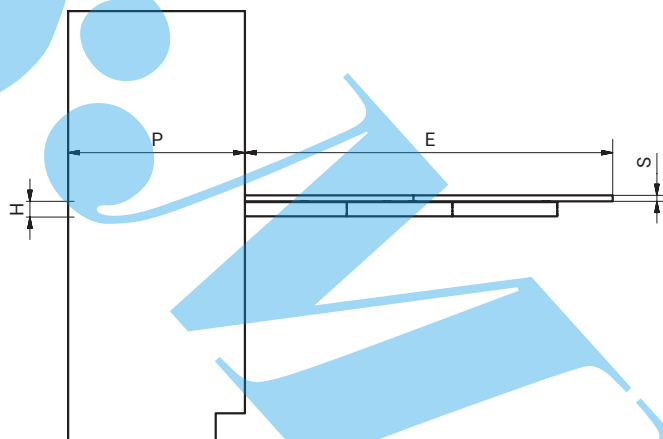
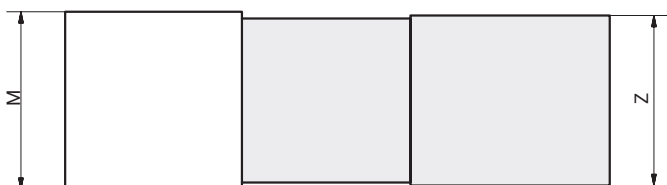

CODICE CODE	M	P MIN	H MIN	S1	E	Z MIN	S	SILENT
411/78.1200.22	600	540	54	15/20	1100	555	16	78.1200.22
411/78.1210.22	900	540	54	15/20	1100	855	16	78.1210.22
411/78.1220.22	1200	540	54	15/20	1100	1155	16	78.1220.22

Valori espressi in millimetri. Value expressed in millimetres.

Legenda tabella a pagina 112. Table key on page 112.



Cook

TAVOLO DA CASSETTO ESTRAIBILE CON VANO
PULL-OUT DRAWER TABLE WITH SPACE

DESIGN

Arch. Giulio Manzoni
ATIM R&S / ATIM R&D

FINITURA FINISHING

Inox Bronzino

PORTATA LOAD CAPACITY

60 Kg equamente distribuiti
60 Kg evenly distributed

PACKAGING

118x18x8 cm
5 Kg
0,017 m³

SCORRIMENTO SLIDING

Alluminio / Alluminio
Aluminium / Aluminium

OPTIONAL

su richiesta on request

KIT TAPPI KIT CAPS

2.9247221.XX

CERNIERE HINGES

2.8029912.12

2.8048168.06



NOTE
L'articolo non prevede la fornitura delle parti in legno.
The item does not include the supply of wooden parts.

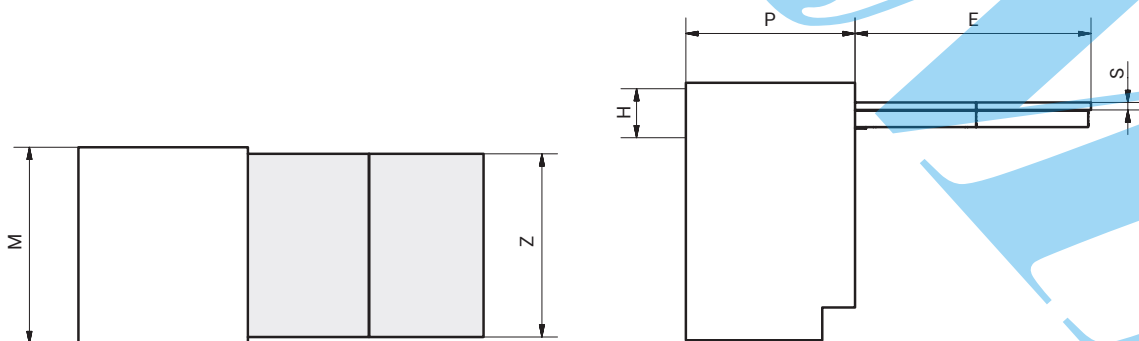

CODICE CODE	M	P MIN	H MIN	S1	E	Z	S MIN	SILENT
411/78.1490.25	600	520	120	15/20	720	555	18	78.1490.25
411/78.1491.25	900	520	120	15/20	720	855	18	78.1491.25

Valori espressi in millimetri. Value expressed in millimetres.

Legenda tabella a pagina 112. Table key on page 112.



Functional

TAVOLO DA CASSETTO ESTRAIBILE CON VANO
PULL-OUT DRAWER TABLE WITH SPACE

DESIGN

Arch. Giulio Manzoni
ATIM R&S / ATIM R&D

FINITURA FINISHING

Inox bronzino

PORTATA LOAD CAPACITY

40 Kg equamente distribuiti
40 Kg evenly distributed

PACKAGING

118x18x8 cm
4 Kg
0,017 m³

SCORRIMENTO SLIDING

Alluminio / Alluminio
Aluminium / Aluminium

OPTIONAL

su richiesta on request

KIT TAPPI KIT CAPS

2.9249311.XX

CERNIERE HINGES

2.8016912.06

2.8029912.12

2.8048168.06



NOTE

L'articolo non prevede la fornitura delle parti in legno.
The item does not include the supply of wooden parts.

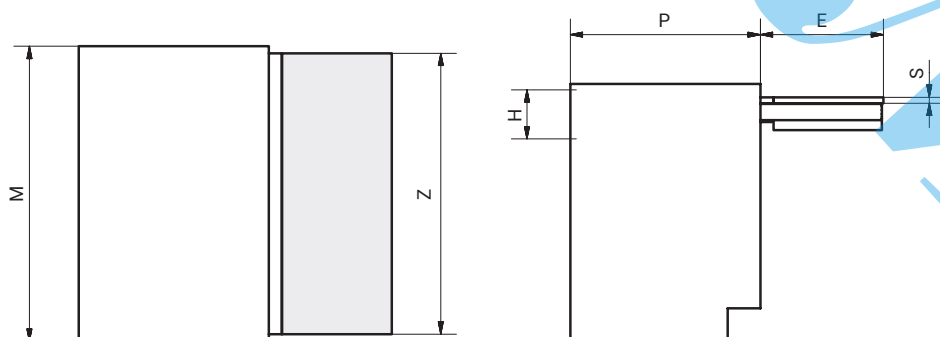

CODICE CODE	M	P MIN	H MIN	S1	E	Z MIN	S MIN	SILENT
411/78.1493.25	600	450	110	15/20	350	555	16	78.1493.25
411/78.1494.25	900	450	110	15/20	350	855	16	78.1494.25

Valori espressi in millimetri. Value expressed in millimetres.

Legenda tabella a pagina 112. Table key on page 112.



Basket K

PANIERE CON PIANO ESTRAIBILE
PULL-OUT BREAD BAG WITH TOP

FINITURA FINISHING

Inox bronzino

PORTATA LOAD CAPACITY

40 Kg equamente distribuiti
40 Kg evenly distributed

PACKAGING

118x18x8 cm
4 Kg
0,017 m³

SCORRIMENTO SLIDING

Alluminio / Alluminio
Aluminium / Aluminium

OPTIONAL

su richiesta on request

KIT TAPPI KIT CAPS

2.9249311.XX

CERNIERE HINGES

2.8016912.06

2.8029912.12

2.8048168.06

NOTE

L'articolo non prevede la fornitura delle parti in legno.
L'articolo è fornito con sacco in tessuto.
The item does not include the supply of wooden parts.
The item supplied with fabric bag.

DESIGN

Arch. Giulio Manzoni
ATIM R&S / ATIM R&D

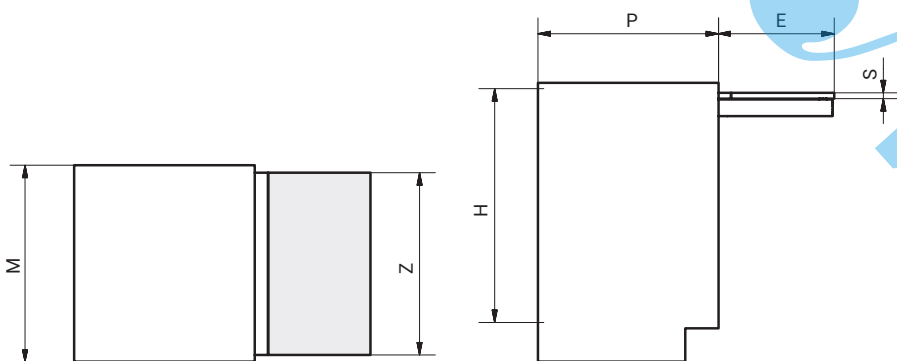
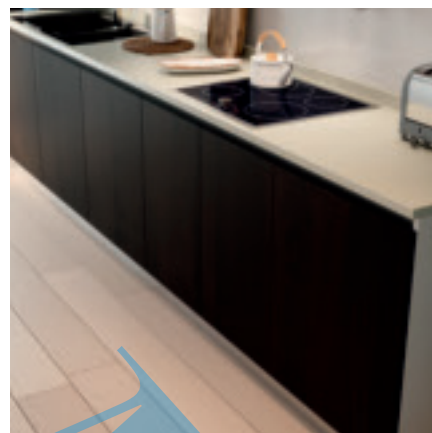

CODICE CODE	M	P MIN	H MIN	S1	E	Z	S MIN	SILENT
411/78.1497.25	450	450	690	15/20	350	405	16	78.1497.25
411/78.1498.25	600	450	690	15/20	350	555	16	78.1498.25

Valori espressi in millimetri. Value expressed in millimetres.

Legenda tabella a pagina 112. Table key on page 112.



Zip

TAVOLO DA CASSETTO ESTRAIBILE CON
SISTEMA SINCRONO: APERTO/CHIUSO
BLOCCO/SBLOCCO
PULL-OUT DRAWER TABLE WITH
SYNCHRONOUS SYSTEM:
OPEN/CLOSE LOCK/UNLOCK

FINITURA FINISHING

Anodizzato naturale (Grigio satinato)
Anodised aluminium (Gray satin)

PORTATA LOAD CAPACITY

80 Kg equamente distribuiti
80 Kg evenly distributed

PACKAGING

118x18x8 cm
5 Kg
0,017 m³

SCORRIMENTO SLIDING

Cuscinetti a sfera
Ball-bearing slide system

OPTIONAL

su richiesta on request

KIT TAPPI

KIT CAPS

2.9251951.XX

CERNIERE

HINGES

2.8016912.06

2.8029912.12

2.8048168.06

DESIGN

Arch. Giulio Manzoni
ATIM R&S / ATIM R&D



NOTE

L'articolo non prevede la fornitura delle parti in legno.
The item does not include the supply of wooden parts.

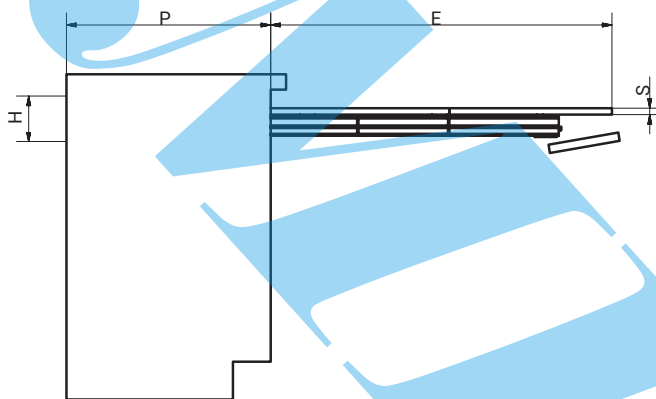
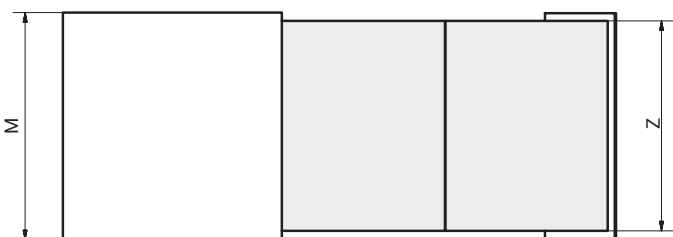

CODICE CODE	M	P MIN	H MIN	S1	E	Z MIN	S
411/78.1261.22	600	550	120	15/20	900	555	18
411/78.1262.22	900	550	120	15/20	900	855	18

Valori espressi in millimetri. Value expressed in millimetres.

Legenda tabella a pagina 112. Table key on page 112.



Ready

TAVOLO DA CASSETTO ESTRAIBILE CON
SISTEMA SINCRONO: APERTO/CHIUSO
PULL-OUT DRAWER TABLE WITH
SYNCHRONOUS SYSTEM: OPEN/CLOSE

FINITURA FINISHING

Inox Bronzino

PORTATA LOAD CAPACITY

60 Kg equamente distribuiti
60 Kg evenly distributed

PACKAGING

118x18x8 cm
5 Kg
0,017 m³

SCORRIMENTO SLIDING

Alluminio / Alluminio
Aluminium / Aluminium

OPTIONAL

su richiesta on request

KIT TAPPI KIT CAPS

2.9247231.XX

PIANO TOP TABLE

Truciolare bianco
White chipboard

Ready 600
2.9152806.12M

Ready 900
2.9152826.12M

DESIGN

Arch. Giulio Manzoni
ATIM R&S / ATIM R&D



NOTE
L'articolo non prevede la fornitura delle parti in legno.
The item does not include the supply of wooden parts.

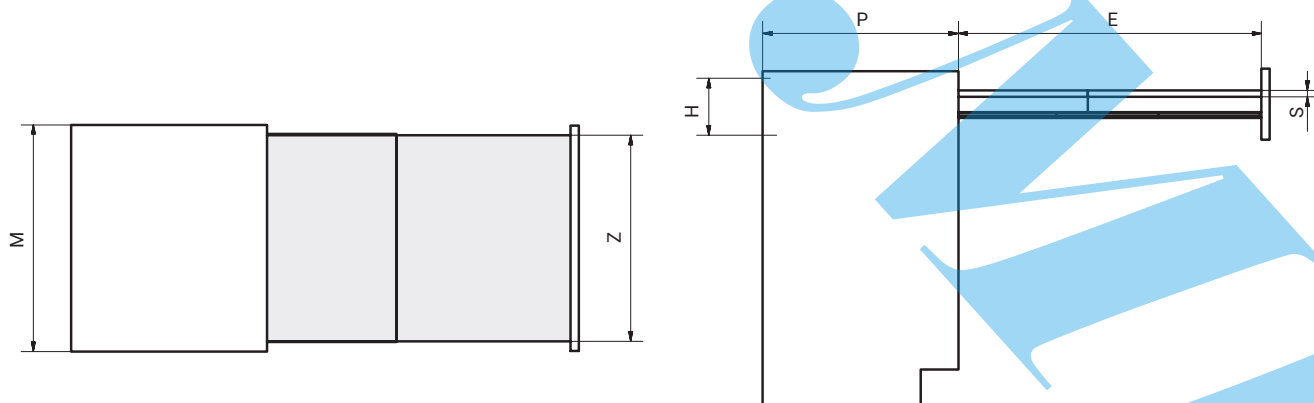

CODICE CODE	M	P MIN	H MIN	S1	E	Z MIN	S	SILENT
411/78.1141.25	600	490	150	15/20	800	540	16/18	78.1141.25
411/78.1142.25	900	490	150	15/20	800	840	16/18	78.1142.25

Valori espressi in millimetri. Value expressed in millimetres.

Legenda tabella a pagina 112. Table key on page 112.



T-Able / T-Able XL

TAVOLO DA CASSETTO ESTRAIBILE
CON GAMBA SINGOLA ABBATTIBILE TELESCOPICA
PULL-OUT DRAWER TABLE
WITH SINGLE TELESCOPIC FOLDING LEG

DESIGN

Arch. Giulio Manzoni
ATIM R&S / ATIM R&D

FINITURA FINISHING

Inox bronzino

PORTATA LOAD CAPACITY

100 Kg equamente distribuiti
100 Kg evenly distributed

PACKAGING

T-Able
118x18x8 cm
7,5 Kg
0,017 m³

T-Able XL
118x18x8 cm
8 Kg
0,017 m³

SCORRIMENTO SLIDING

Alluminio / Alluminio
Aluminium / Aluminium

OPTIONAL

su richiesta on request

KIT TAPPI KIT CAPS

T-Able
2.9247231.XX

T-Able XL
2.9247251.XX

PIANO TOP TABLE

Truciolare bianco
White chipboard

T-Able 600
3.9129876.12 M

T-Able 900
3.9129866.12 M

T-Able XL 600
3.9155026.12 M

T-Able XL 900
3.9155036.12 M

CERNIERE HINGES

2.8016912.06

2.8029912.12

2.8048168.06

NOTE
L'articolo non prevede la fornitura delle parti in legno.
The item does not include the supply of wooden parts

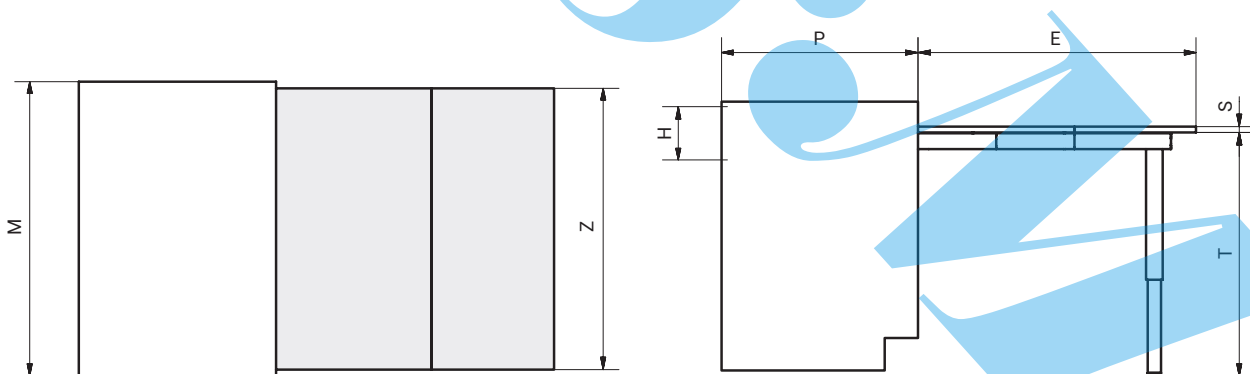

T-Able

CODICE CODE	M	P MIN	H MIN	S1	E	Z MIN	S MIN	T	SILENT
411/78.1900.22	600	540	120	15/20	900	555	16	745/840	78.1900.22
411/78.1910.22	900	540	120	15/20	900	855	16	745/840	78.1910.22
411/78.1920.22	1200	540	120	15/20	900	1155	16	745/840	78.1920.22

Valori espressi in millimetri. Value expressed in millimetres.

Legenda tabella a pagina 112. Table key on page 112.

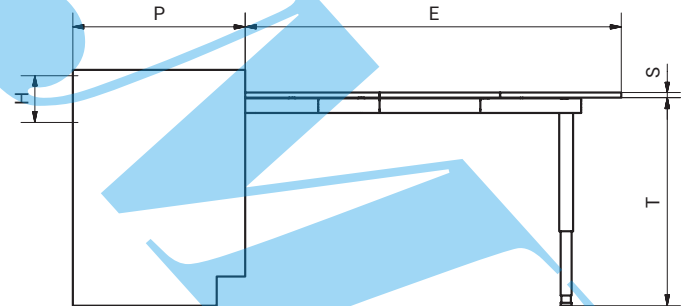
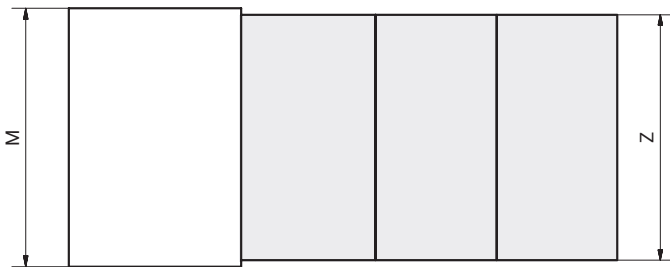

T-Able XL

CODICE CODE	M	P MIN	H MIN.	S1	E	Z MIN	S MIN	T	SILENT
411/78.1900.22X	600	520	150	15/20	1310	555	16	700/795	78.1900.22X
411/78.1910.22X	900	520	150	15/20	1310	855	16	700/795	78.1910.22X
411/78.1920.22X	1200	520	150	15/20	1310	1155	16	700/795	78.1920.22X

Valori espressi in millimetri. Value expressed in millimetres.

Legenda tabella a pagina 112. Table key on page 112.

Just

PIANO A RIBALTA CON GAMBA SINGOLA
ABBATTIBILE TELESCOPICA
TILTING TOP WITH SINGLE TELESCOPIC
FOLDING LEG

FINITURA FINISHING

Inox Bronzino

PORTATA LOAD CAPACITY

100 Kg equamente distribuiti
100 Kg evenly distributed

PACKAGING

118x18x8 cm
4 Kg
0,017 m³

SCORRIMENTO SLIDING

Alluminio / Alluminio
Aluminium / Aluminium

DESIGN

ATIM R&S / ATIM R&D

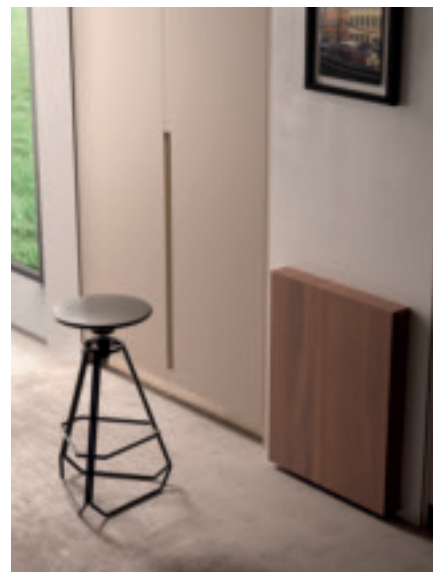

NOTE

L'articolo non prevede la fornitura delle parti in legno.
The item does not include the supply of wooden parts.

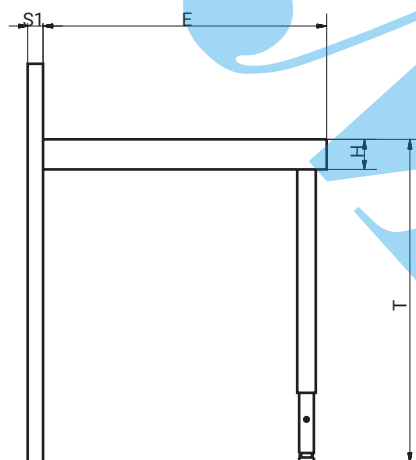
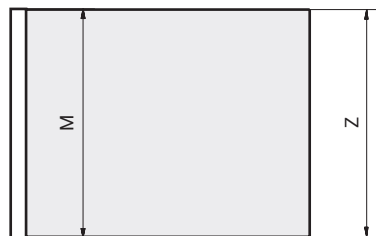

CODICE CODE	M	H MIN	T	S1 MIN	E	Z MIN	S MIN
411/78.1990.25	600	80	855	40	750	600	18

Valori espressi in millimetri. Value expressed in millimetres.

Legenda tabella a pagina 112. Table key on page 112.



T-Bench / T-Bench XL

DESIGN

Arch. Giulio Manzoni
ATIM R&S / ATIM R&D

SEDUTA DA CASSETTO ESTRAIBILE
CON GAMBA SINGOLA ABBATTIBILE
PULL-OUT DRAWER BENCH
WITH SINGLE FOLDING LEG

FINITURA FINISHING

Inox bronzino

PORTATA LOAD CAPACITY

100 Kg equamente distribuiti
100 Kg evenly distributed

PACKAGING

T-Bench
118x18x8 cm
6,5 Kg
0,017 m³

T-Bench XL
118x18x8 cm
8 Kg
0,017 m³

SCORRIMENTO SLIDING

Alluminio / Alluminio
Aluminium / Aluminium

OPTIONAL

su richiesta on request

KIT TAPPI KIT CAPS

T-Bench
2.9247231.XX

T-Bench XL
2.9247251.XX

PIANO TOP TABLE

Truciolare bianco
White chipboard

T-Bench 450
3.9132836.12 M

T-Bench 600
3.9129876.12 M

T-Bench XL 600
3.9155026.12 M

CERNIERE HINGES

2.8016912.06
2.8029912.12
2.8048168.06

NOTE
L'articolo non prevede la fornitura delle parti in legno.
The item does not include the supply of wooden parts

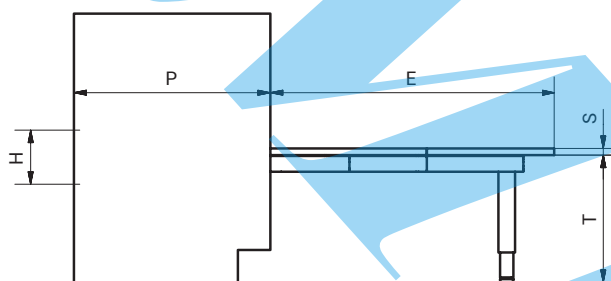
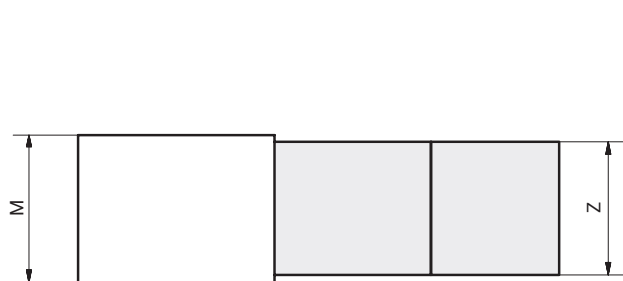

T-Bench

CODICE CODE	M	P MIN	H MIN.	S1	E	Z MIN	S MIN	T	SILENT
411/78.1950.22	450	540	120	15/20	870	405	16	385/410	78.1950.22
411/78.1960.22	600	540	120	15/20	870	555	16	385/410	78.1960.22

Valori espressi in millimetri. Value expressed in millimetres.

Legenda tabella a pagina 112. Table key on page 112.

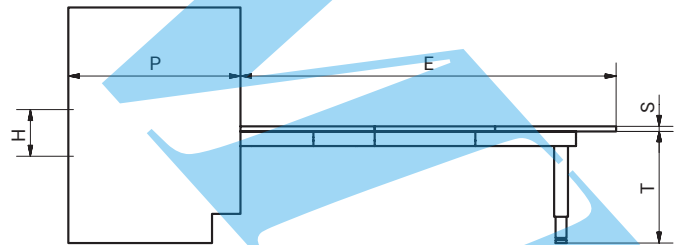

T-Bench XL

CODICE CODE	M	P MIN	H MIN.	S1	E	Z MIN	S MIN	T	SILENT
411/78.1960.22X	600	520	150	15/20	1310	555	16	385/410	78.1960.22X

Valori espressi in millimetri. Value expressed in millimetres.

Legenda tabella a pagina 112. Table key on page 112.

Party

TAVOLO DA CASSETTO ESTRAIBILE
CON GAMBA DOPPIA ABBATTIBILE TELESCOPICA
PULL-OUT DRAWER TABLE
WITH DOUBLE TELESCOPIC FOLDING LEG

DESIGN

Arch. Giulio Manzoni
ATIM R&S / ATIM R&D

FINITURA FINISHING

Inox Bronzino

PORTATA LOAD CAPACITY

100 Kg equamente distribuiti
100 Kg evenly distributed

PACKAGING

118x18x8 cm
11 Kg
0,017 m³

SCORRIMENTO SLIDING

Alluminio / Alluminio
Aluminium / Aluminium

OPTIONAL

su richiesta on request

KIT TAPPI KIT CAPS

2.9247251.XX

PIANO TOP TABLE

Truciolare bianco
White chipboard

Party 600 3.9136476.12 M

Party 900 3.9136486.12 M

Party 1200 2.9136496.12 M

CERNIERE HINGES

2.8016912.06

2.8029912.12

2.8048168.06



NOTE
L'articolo non prevede la fornitura delle parti in legno.
The item does not include the supply of wooden parts

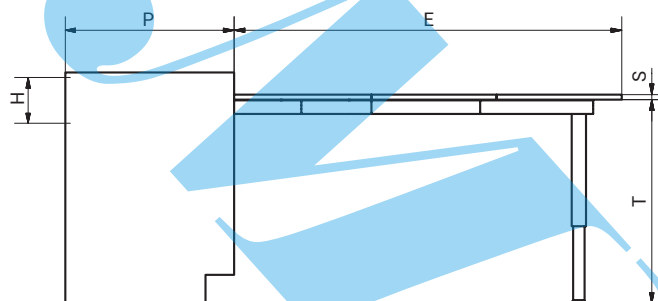
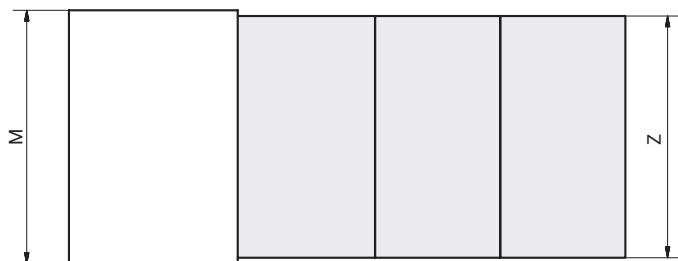

CODICE CODE	M	P MIN	H MIN	S1	E	Z MIN	S MIN	T	SILENT
411/78.1500.22	600	560	150	16/19	1380	557	16	725/820	78.1500.22
411/78.1510.22	900	560	150	16/19	1380	857	16	725/820	78.1510.22
411/78.1520.22	1200	560	150	16/19	1380	1157	16	725/820	78.1520.22

Valori espressi in millimetri. Value expressed in millimetres.

Legenda tabella a pagina 112. Table key on page 112.



Mensola Party

TAVOLO DA CASSETTO ESTRAIBILE
CON GAMBA DOPPIA ABBATTIBILE TELESCOPICA
PULL-OUT DRAWER TABLE
WITH DOUBLE TELESCOPIC FOLDING LEG

FINITURA FINISHING

Inox Bronzino

PORTATA LOAD CAPACITY

100 Kg equamente distribuiti
100 Kg evenly distributed

PACKAGING

105x34x8 cm
14 Kg
0,03 m³

SCORRIMENTO SLIDING

Alluminio / Alluminio
Aluminium / Aluminium

OPTIONAL

su richiesta on request

KIT TAPPI KIT CAPS

2.9247281.XX

DESIGN

Arch. Giulio Manzoni
ATIM R&S / ATIM R&D



NOTE
L'articolo non prevede la fornitura delle parti in legno.
The item does not include the supply of wooden parts

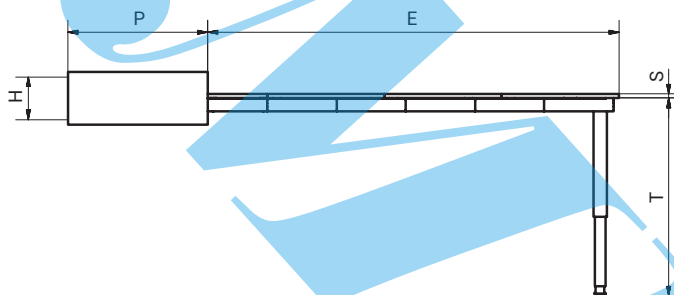
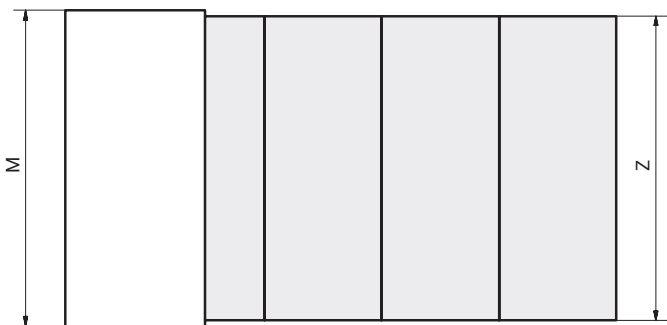

CODICE CODE	M	P MIN	H MIN	S1	E	Z MIN	S	T	SILENT
411/78.1601.22	600	502	140	18,5	1540	555	14	730/755	78.1601.22
411/78.1602.22	900	502	140	18,5	1540	855	14	730/755	78.1602.22
411/78.1600.22	1200	502	140	18,5	1540	1155	14	730/755	78.1600.22

Valori espressi in millimetri. Value expressed in millimetres.

Legenda tabella a pagina 112. Table key on page 112.



Evolution / Evolution XL

TAVOLO DA CABINET ESTRAIBILE CON GAMBA A PONTE
PULL-OUT CABINET TABLE WITH BRIDGE LEG

FINITURA

FINISHING

Inox bronzino
Guide/Slides

Grigio /Grey Ral 7012
Gamba/Leg

VERSIONE NAKED (N)

NAKED VERSION (N)

Gamba
Nero opaco RAL 9005.
Senza traversi per fissaggio anta
Leg
Matt black RAL 9005.
Without bar for door fixing

PORTATA

LOAD CAPACITY

100 Kg equamente distribuiti
100 Kg evenly distributed

SCORRIMENTO

SLIDING

Alluminio / Alluminio
Aluminium / Aluminium

PACKAGING (2 packages)

Guide/Slides
118x18x8 cm
6 Kg
0,017 m³

Gamba/Leg
Evolution 600
Evolution XL 600
57x77x8 cm
8 Kg
0,035 m³

Evolution 900
Evolution XL 900
87x88x8 cm
11 Kg
0,055 m³

Evolution 1200
Evolution XL 1200
117x88x8 cm
14 Kg
0,072 m³

DESIGN

Arch. Giulio Manzoni
ATIM R&S / ATIM R&D

OPTIONAL

su richiesta on request

KIT TAPPI

KIT CAPS

Evolution 2.9247241.XX
EvolutionXL 2.9247271.XX

CERNIERE

HINGES

2.8016912.06
2.8029912.12
2.8048168.06

PIANO

TOP TABLE

Evolution XL 900
3.9141776.12 M

NOTE

L'articolo non prevede la fornitura delle parti in legno.
The item does not include the supply of wooden parts

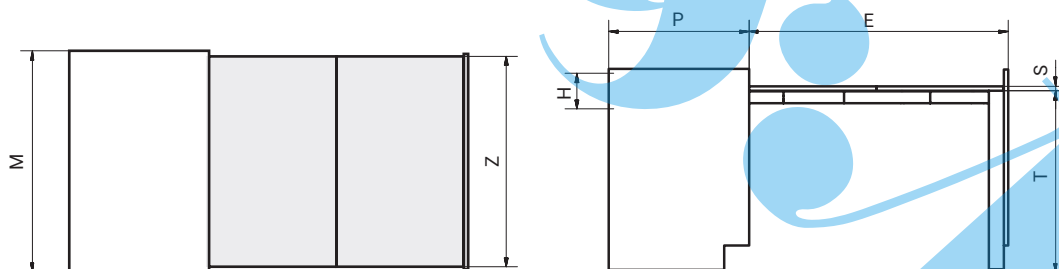

Evolution

CODICE CODE	M	P MIN	H MIN	S1	E	Z MIN	S MIN	T	SILENT
411/78.1610.25	600	520	120	15/20	1040	555	16	730/755	78.1610.25
411/78.1611.25	900	520	120	15/20	1040	855	16	730/755	78.1611.25
411/78.1612.25	1200	520	120	15/20	1040	1155	16	730/755	78.1612.25
411/78.1610.25N	600	520	120	15/20	1040	555	16	730/755	78.1610.25N
411/78.1611.25N	900	520	120	15/20	1040	855	16	730/755	78.1611.25N
411/78.1612.25N	1200	520	120	15/20	1040	1155	16	730/755	78.1612.25N

Valori espressi in millimetri. Value expressed in millimetres.

Legenda tabella a pagina 112. Table key on page 112.

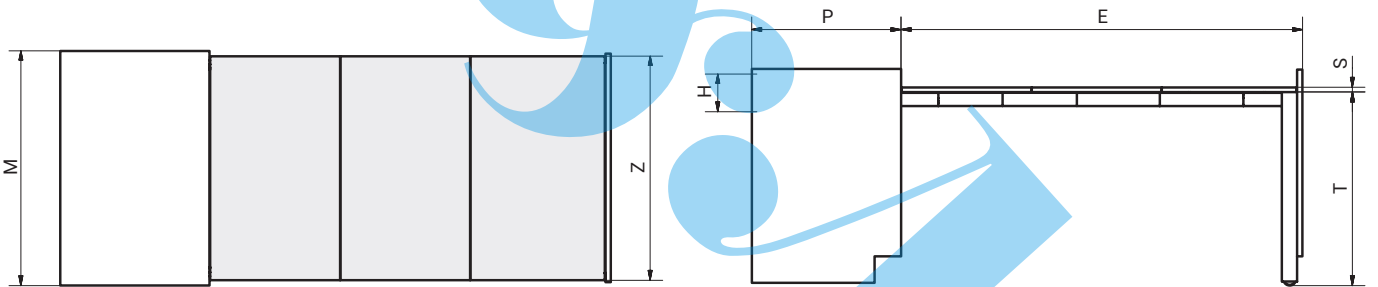

Evolution XL

CODICE CODE	M	P MIN	H MIN	S1	E	Z MIN	S MIN	T	SILENT
411/78.1620.25	600	520	150	15/20	1520	555	16	730/755	78.1620.25
411/78.1621.25	900	520	150	15/20	1520	855	16	730/755	78.1621.25
411/78.1622.25	1200	520	150	15/20	1520	1155	16	730/755	78.1622.25
411/78.1620.25N	600	520	150	15/20	1520	555	16	730/755	78.1620.25N
411/78.1621.25N	900	520	150	15/20	1520	855	16	730/755	78.1621.25N
411/78.1622.25N	1200	520	150	15/20	1520	1155	16	730/755	78.1622.25N

Valori espressi in millimetri. Value expressed in millimetres.

Legenda tabella a pagina 112. Table key on page 112.

Oplà Top

PIANO ESTRAIBILE FILO TOP
PULL-OUT TOP ALLIGNED WITH COUNTER TOP

DESIGN

Arch. Giulio Manzoni
ATIM R&S / ATIM R&D

FINITURA FINISHING

Inox Bronzino

PORTATA LOAD CAPACITY

40 Kg equamente distribuiti
40 Kg evenly distributed

PACKAGING

118x18x8 cm
4,5 Kg
0,017 m³

SCORRIMENTO SLIDING

Alluminio / Alluminio
Aluminium / Aluminium

OPTIONAL

su richiesta on request

KIT TAPPI KIT CAPS

2.9247221.XX

NOTE
L'articolo non prevede la fornitura delle parti in legno.
The item does not include the supply of wooden parts

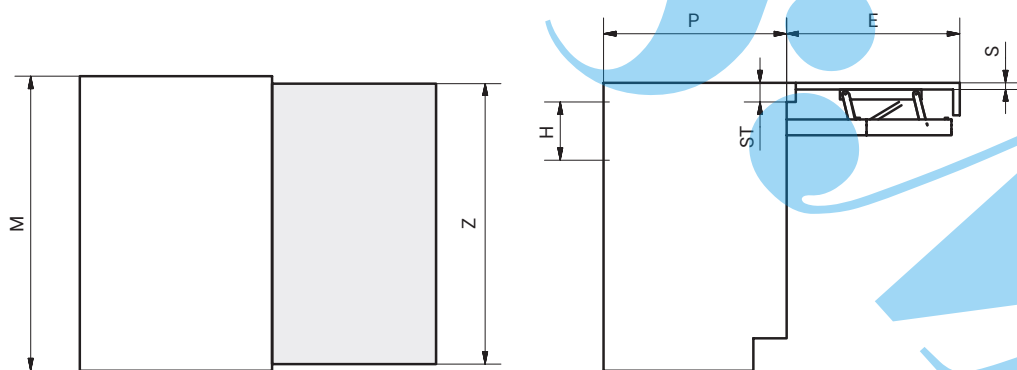

CODICE CODE	M	P MIN	H MIN	S1	E	Z MIN	S	ST	SILENT
411/78.1750.22	450	540	75	15/20	500	405	20/60	20/60	78.1750.22
411/78.1760.22	600	540	75	15/20	500	555	20/60	20/60	78.1760.22
411/78.1770.22	900	540	75	15/20	500	855	20/60	20/60	78.1770.22
411/78.1780.22	1200	540	75	15/20	500	1155	20/60	20/60	78.1780.22

Valori espressi in millimetri. Value expressed in millimetres.

Legenda tabella a pagina 112. Table key on page 112.



Sandwich

TOP ESTRAIBILE CON EASYBOOK
PULL-OUT TOP WITH EASYBOOK

FINITURA FINISHING

Anodizzato naturale
Grigio satinato

Anodised aluminium
Gray satin

PORTATA LOAD CAPACITY

80 Kg equamente distribuiti
80 Kg evenly distributed

PACKAGING

118x18x8 cm
5,5 Kg
0,017 m³

SCORRIMENTO SLIDING

Cuscinetti a sfera
Ball-bearing slide system

OPTIONAL

su richiesta on request

KIT TAPPI KIT CAPS

2.9250551.XX

CERNIERE HINGES

2.8016912.06

2.8029912.12

2.8048168.06

DESIGN

Arch. Giulio Manzoni
ATIM R&S / ATIM R&D



NOTE
L'articolo non prevede la fornitura delle parti in legno.
The item does not include the supply of wooden parts.

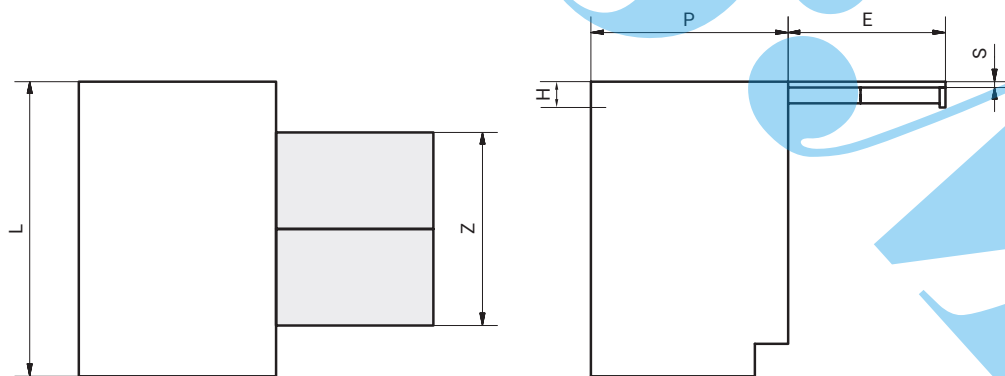

CODICE CODE	L MIN	P MIN	H MIN	E	Z	S
411/78.1850.22	592	540	80	510	590	18
411/78.1860.22	802	540	80	510	800	18
411/78.1870.22	1102	540	80	510	1100	18

Valori espressi in millimetri. Value expressed in millimetres.

Legenda tabella a pagina 112. Table key on page 112.



Flip Top

PIANO DA CASSETTO ESTRAIBILE CON EASYBOOK
PULL-OUT DRAWER WORKTOP WITH EASYBOOK

DESIGN

Arch. Giulio Manzoni
ATIM R&S / ATIM R&D

FINITURA FINISHING

Inox Bronzino

PORTATA LOAD CAPACITY

80 Kg equamente distribuiti
80 Kg evenly distributed

PACKAGING

118x18x8 cm
5 Kg
0,017 m³

SCORRIMENTO SLIDING

Alluminio / Alluminio
Aluminium / Aluminium

OPTIONAL

su richiesta on request

KIT TAPPI KIT CAPS

2.9247221.XX

CERNIERE HINGES

2.8016912.06
2.8029912.12
2.8048168.06



NOTE
L'articolo non prevede la fornitura delle parti in legno.
The item does not include the supply of wooden parts

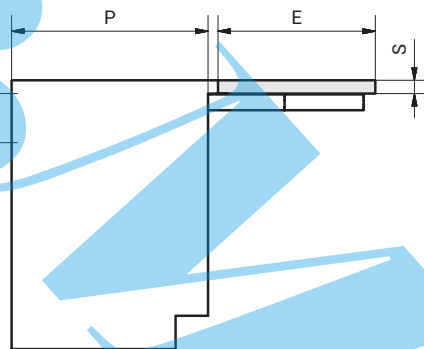
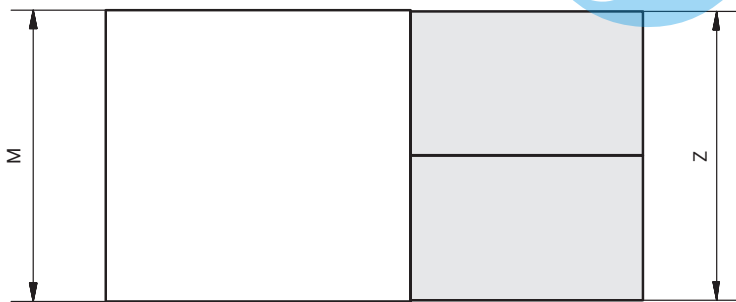

CODICE CODE	M	P MIN	H MIN	S1	E	Z MIN	S MIN	SILENT
411/78.1800.22	450	540	120	15/20	480	450	16	78.1800.22
411/78.1810.22	600	540	120	15/20	480	600	16	78.1810.22
411/78.1820.22	900	540	120	15/20	480	900	16	78.1820.22
411/78.1830.22	1200	540	120	15/20	480	1200	16	78.1830.22

Valori espressi in millimetri. Value expressed in millimetres.

Legenda tabella a pagina 112. Table key on page 112.



Breakfast

PIANO ESTRAIBILE
PULL-OUT TOP

FINITURA FINISHING

Anodizzato naturale
Grigio satinato

Anodised aluminium
Gray satin

PORTATA LOAD CAPACITY

60 Kg equamente distribuiti
60 Kg evenly distributed

PACKAGING

187x17x12 cm
22 Kg
0,04 m³

SCORRIMENTO SLIDING

Cuscinetti a sfera
Ball-bearing slide system

OPTIONAL

su richiesta on request

KIT TAPPI KIT CAPS

2.9250571.XX

SOFT MOVE (SM)

Sistema scorrevole elettrificato
con comando a distanza
Electrified sliding system
with remote control

DESIGN

Arch. Giulio Manzoni
ATIM R&S / ATIM R&D



NOTE

L'articolo non prevede la fornitura delle parti in legno.
The item does not include the supply of wooden parts

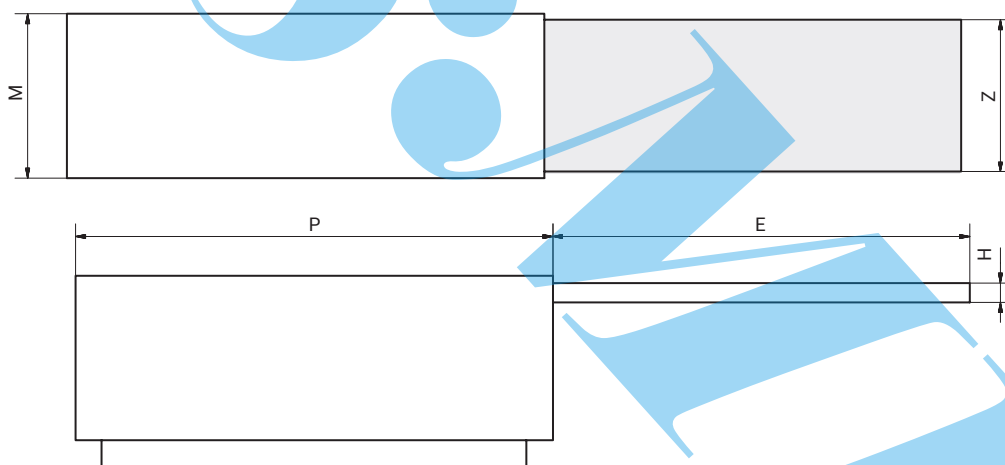

CODICE CODE	M MIN	P MIN	H MIN	E	Z MIN	S MIN
411/78.1251.22	600	1780	80	1600	580	18
411/78.1251 SM	600	1780	100	1600	580	18

Valori espressi in millimetri. Value expressed in millimetres.

Legenda tabella a pagina 112. Table key on page 112.



Breakfast Top

PIANO SCORREVOLE SU TOP
SLIDING TABLE TOP

FINITURA FINISHING

Anodizzato naturale
Grigio satinato

Anodised aluminium
Gray satin

PORTATA LOAD CAPACITY

60 Kg equamente distribuiti
60 Kg evenly distributed

PACKAGING

245x16x12 cm
17 Kg
0,05 m³

SCORRIMENTO SLIDING

Cuscinetti a sfera
Ball-bearing slide system

OPTIONAL

su richiesta on request

KIT TAPPI KIT CAPS

2.9250571.XX

SOFT MOVE (SM)

Sistema scorrevole elettrificato
con comando a distanza
Electrified sliding system
with remote control
H min = 150 mm

NOTE
L'articolo non prevede la fornitura delle parti in legno.
The item does not include the supply of wooden parts

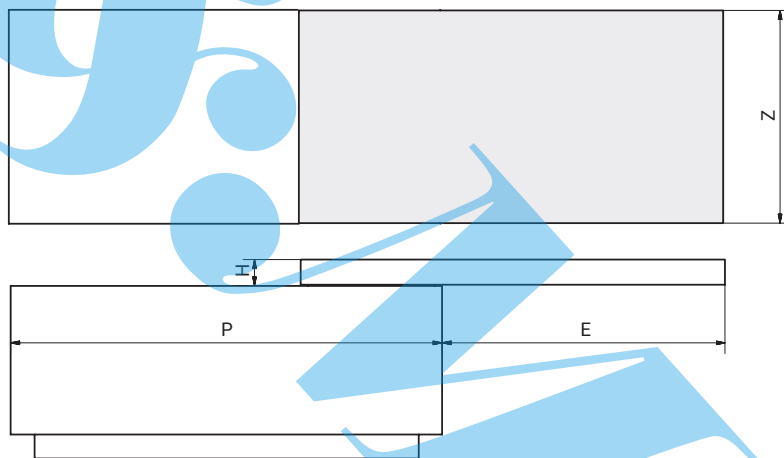

CODICE CODE	P MIN.	H MIN	Z MIN	E	S MIN
411/78.1252.22	1200	85	850	900	18
411/78.1253.22	1800	85	850	1200	18
411/78.1254.22	2400	85	850	1500	18
411/78.1255.22	3000	85	850	1500	18

Valori espressi in millimetri. Value expressed in millimetres.

Legenda tabella a pagina 112. Table key on page 112.



Slide

PIANO SCORREVOLE SU TOP
SLIDING TABLE TOP

FINITURA FINISHING

Anodizzato naturale
Grigio satinato

Anodised aluminium
Gray satin

PORTATA LOAD CAPACITY

60 Kg equamente distribuiti
60 Kg evenly distributed

PACKAGING

118x46x7 cm
9 Kg
0,039 m³

SCORRIMENTO SLIDING

Cuscinetti a sfera
Ball-bearing slide system

OPTIONAL

su richiesta on request

KIT TAPPI KIT CAPS

2.9250551.XX

NOTE

L'articolo non prevede la fornitura delle parti in legno.
The item does not include the supply of wooden parts.

DESIGN

ATIM R&S / ATIM R&D

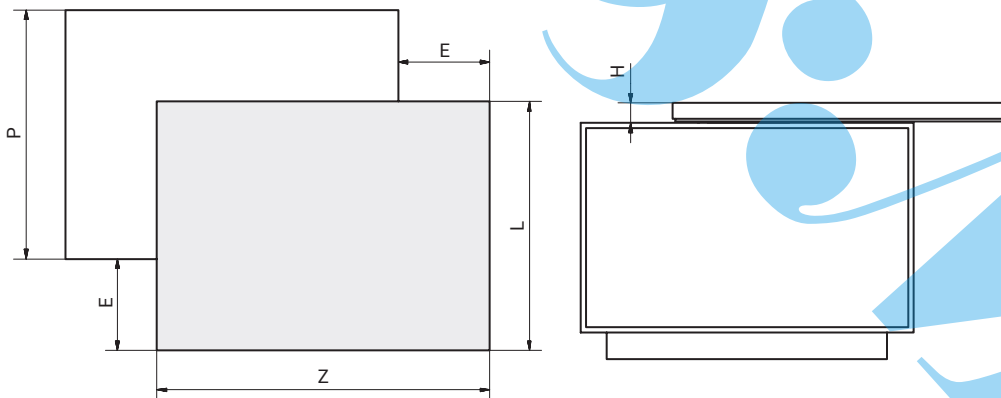

CODICE CODE	APERTURA OPENING	P MIN	H MIN	Z	L	S MIN	E
411/78.1241.22	SX/DX (L/R)	1200	75	1200	1200	18	350
411/78.1242.22	DX (R)	950	75	1200	950	18	350
411/78.1243.22	SX (L)	950	75	1200	950	18	350
411/78.1245.22	SX/DX (L/R)	900	75	900	900	18	315

Valori espressi in millimetri. Value expressed in millimetres.

Legenda tabella a pagina 112. Table key on page 112.



Snack

PIANO SCORREVOLE
SLIDING TABLE TOP

FINITURA FINISHING

Anodizzato naturale
Grigio satinato

Anodised aluminium
Gray satin

PORTATA LOAD CAPACITY

60 Kg equamente distribuiti
60 Kg evenly distributed

PACKAGING

411/78.1281.22 / SM
245x27x8 cm 13,5 Kg 0,05 m³

411/78.1282.22 / SM
180x27x8 cm 12 Kg 0,04 m³

SCORRIMENTO SLIDING

Cuscinetti a sfera
Ball-bearing slide system

OPTIONAL

su richiesta on request

KIT TAPPI

KIT CAPS

2.9247461.XX

SOFT MOVE (SM)

Sistema scorrevole elettrificato
con comando a distanza
Electrified sliding system
with remote control

NOTE

L'articolo non prevede la fornitura delle parti in legno.
The item does not include the supply of wooden parts

DESIGN

ATIM R&S / ATIM R&D

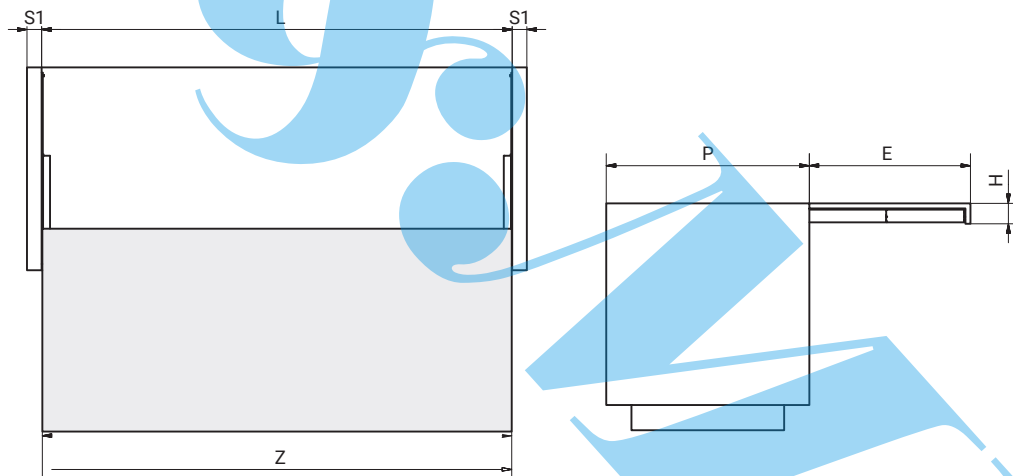

CODICE CODE	L	P MIN	H MIN	S1 MIN	E	S MIN	Z
411/78.1281.22	2467	800	80	40	640	18	2460
411/78.1282.22	1867	800	80	40	640	18	1860
411/78.1281 SM	2467	800	90	40	590	18	2460
411/78.1282 SM	1867	800	90	40	590	18	1860

Valori espressi in millimetri. Value expressed in millimetres.

Legenda tabella a pagina 112. Table key on page 112.



Snack Top

PIANO SCORREVOLE SU TOP
SLIDING TABLE TOP

FINITURA FINISHING

Anodizzato naturale
Grigio satinato

Anodised aluminium
Gray satin

PORTATA LOAD CAPACITY

80 Kg equamente distribuiti
80 Kg evenly distributed

PACKAGING

411/78.1283.22
90x30x6 cm 9 Kg 0,015 m³

411/78.1284.22
120x30x6 cm 13 Kg 0,02 m³

SCORRIMENTO SLIDING

Cuscinetti a sfera
Ball-bearing slide system

VERSIONE AIR (A) AIR VERSION (A)

Sistema di selfclosing, blumotion
in apertura. montato al meccanismo.
Self-closing system, blumotion
mounted to the mechanism.

DESIGN
ATIM R&S / ATIM R&D



NOTE
L'articolo non prevede la fornitura delle parti in legno.
The item does not include the supply of wooden parts

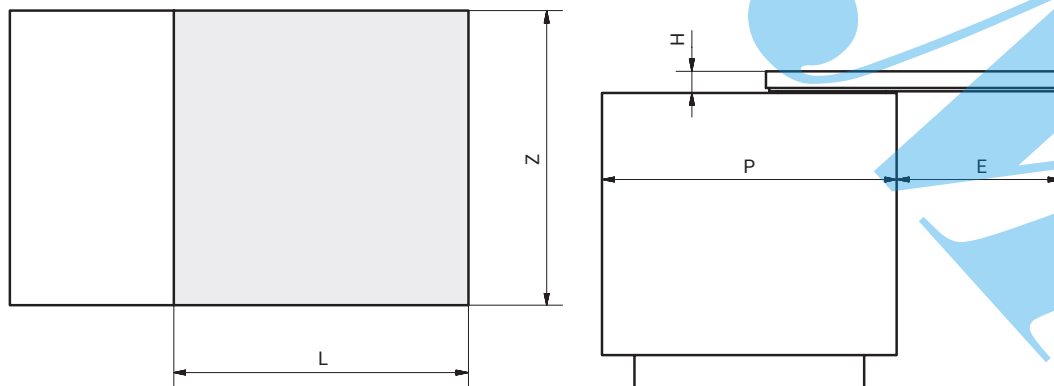

CODICE CODE	P MIN	Z MIN	L MIN	H MIN	E	S MIN	AIR
411/78.1283.22	900	900	900	65	500	18	411/78.1283.22A
411/78.1284.22	1200	1200	1200	65	700	18	411/78.1284.22A

Valori espressi in millimetri. Value expressed in millimetres.

Legenda tabella a pagina 112. Table key on page 112.



Flap

PIANO SCORREVOLE SU TOP
SLIDING TABLE TOP

FINITURA FINISHING

Anodizzato naturale
Grigio satinato

Anodised aluminium
Gray satin

PORTATA LOAD CAPACITY

80 Kg equamente distribuiti
80 Kg evenly distributed

PACKAGING

118x19x15 cm
9 Kg
0,035 m³

SCORRIMENTO SLIDING

Cuscinetti a sfera
Ball-bearing slide system

DESIGN

Arch. Giulio Manzoni
ATIM R&S / ATIM R&D



NOTE
L'articolo non prevede la fornitura delle parti in legno.
The item does not include the supply of wooden parts

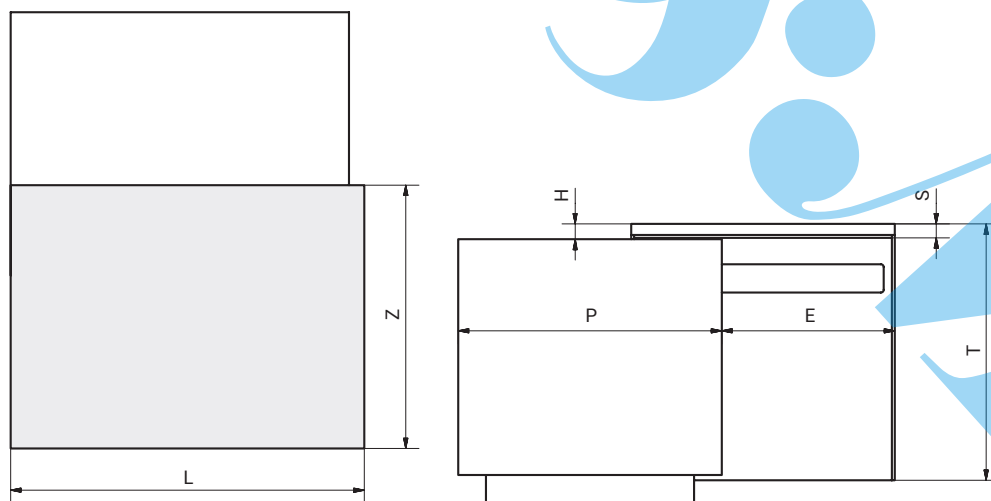

CODICE CODE	P MIN	H MIN	S MIN	E	L	Z	T MIN
411/78.1244.22	950	55	50	600	600/1300	950	450
411/78.1244.22 C	950	55	50	300	600/1300	950	450

Valori espressi in millimetri. Value expressed in millimetres.

Legenda tabella a pagina 112. Table key on page 112.



Corner

PIANO SCORREVOLE SU TOP
SLIDING TABLE TOP

**FINITURA
FINISHING**
Inox bronzino

**PORTATA
LOAD CAPACITY**
60 Kg equamente distribuiti
60 Kg evenly distributed

PACKAGING
118x46x7 cm
9 Kg
0,039 m³

**SCORRIMENTO
SLIDING**
Alluminio / Alluminio
Aluminium / Aluminium

OPTIONAL
su richiesta on request

**KIT TAPPI
KIT CAPS**
2.9247221.XX

**CORNICE STICK
STICK FRAME**

DESIGN

Arch. Giulio Manzoni
ATIM R&S / ATIM R&D

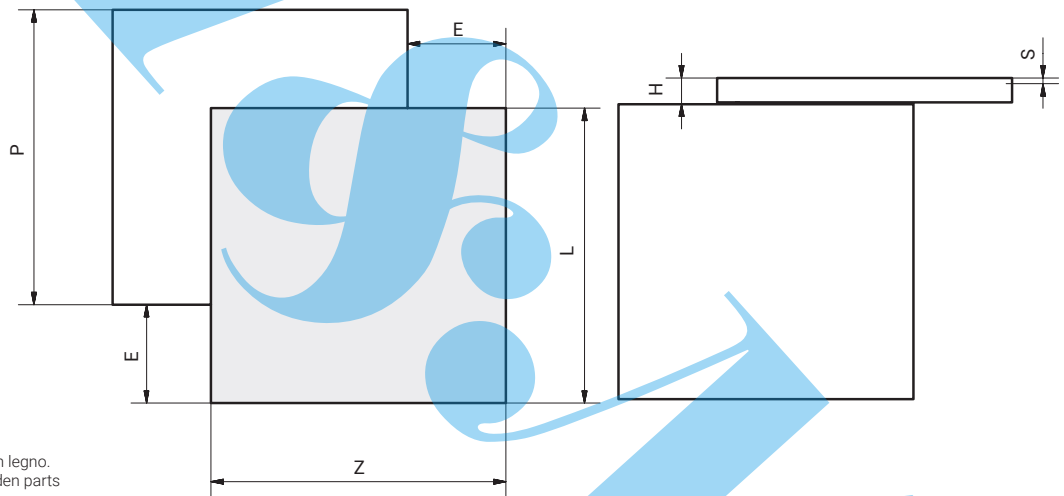

NOTE
L'articolo non prevede la fornitura delle parti in legno.
The item does not include the supply of wooden parts

CODICE CODE	AP	P MIN	H MIN	Z	L	S MIN	E
78.1230.25	SX/DX (L/R)	1200	80	1200	1200	18	350
78.1231.25	DX (R)	900	80	1200	900	18	350
78.1232.25	SX (L)	900	80	1200	900	18	350
78.1233.25	SX/DX (L/R)	900	80	900	900	18	300
78.1234.25	DX (R)	600	80	900	600	18	300
78.1235.25	SX (L)	600	80	900	600	18	300

Valori espressi in millimetri. Value expressed in millimetres.

Legenda tabella a pagina 112. Table key on page 112.



Twice

PIANO SCORREVOLE
SLIDING TOP

**FINITURA
FINISHING**

Inox bronzino

**PORTATA
LOAD CAPACITY**

60 Kg equamente distribuiti
60 Kg evenly distributed

PACKAGING

118x46x7 cm
9 Kg
0,039 m³

**SCORRIMENTO
SLIDING**

Alluminio / Alluminio
Aluminium / Aluminium

OPTIONAL

su richiesta on request

**KIT TAPPI
KIT CAPS**

2.9247221.XX

**CORNICE STICK
STICK FRAME**

DESIGN

Arch. Giulio Manzoni
ATIM R&S / ATIM R&D



NOTE
L'articolo non prevede la fornitura delle parti in legno.
The item does not include the supply of wooden parts

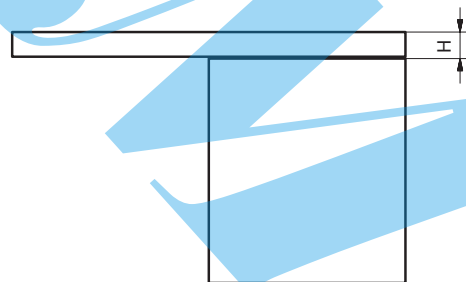
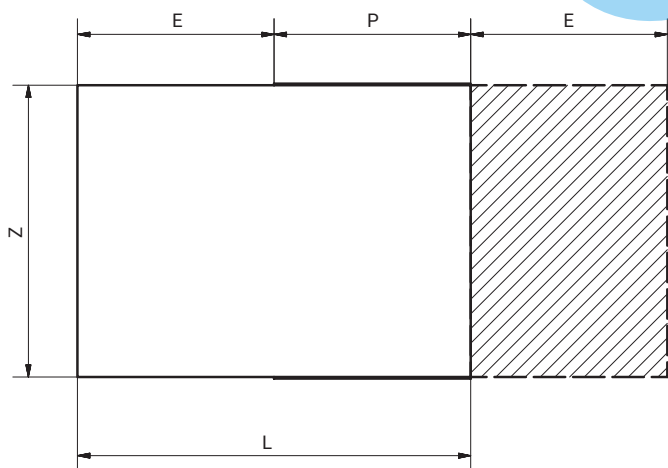

CODICE CODE	P MIN	H MIN	Z MIN	L MAX	S MIN	E MAX
411/78.1480.25	600	80	600	1200	18	600

Valori espressi in millimetri. Value expressed in millimetres.

Legenda tabella a pagina 112. Table key on page 112.



Twice Top

PIANO SCORREVOLE SU TOP
SLIDING TABLE TOP

FINITURA FINISHING

Inox bronzino

PORTATA

LOAD CAPACITY

60 Kg equamente distribuiti
60 Kg evenly distributed

PACKAGING

190x50x7 cm
10 Kg
0,07 m³

SCORRIMENTO SLIDING

Alluminio / Alluminio
Aluminium / Aluminium

OPTIONAL

su richiesta on request

KIT TAPPI

KIT CAPS

2.9247221.XX

CORNICE STICK

STICK FRAME

DESIGN

Arch. Giulio Manzoni
ATIM R&S / ATIM R&D



NOTE

L'articolo non prevede la fornitura delle parti in legno.
The item does not include the supply of wooden parts

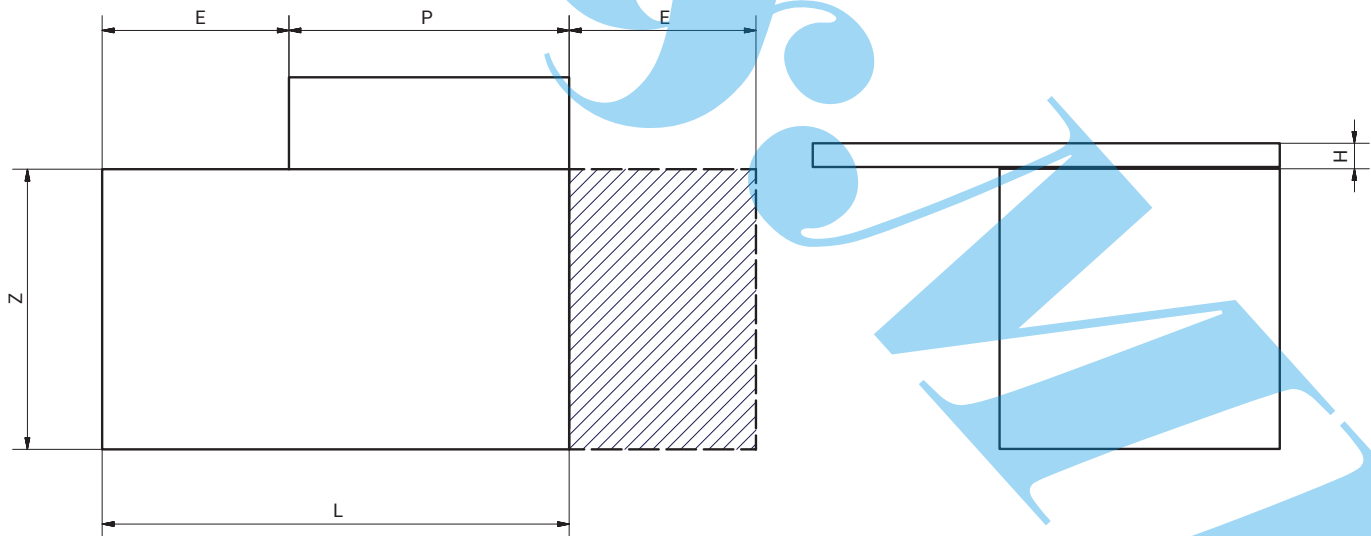

CODICE CODE	P	H MIN	Z MIN	L	S MIN	E
411/78.1470.25	900	80	900	1500	18	600
411/78.1471.25	1200	80	900	1800	18	600

Valori espressi in millimetri. Value expressed in millimetres.

Legenda tabella a pagina 112. Table key on page 112.



Top 33

PIANO SCORREVOLE SU TOP
SLIDING TABLE TOP

FINITURA FINISHING

Anodizzato naturale (Grigio satinato)
Anodised aluminium (Gray satin)

PORTATA LOAD CAPACITY

60 Kg equamente distribuiti
60 Kg evenly distributed

PACKAGING

120x30x6 cm
13 Kg
0,03 m³

SCORRIMENTO SLIDING

Cuscinetti a sfera
Ball-bearing slide system

DESIGN
ATIM R&S / ATIM R&D



NOTE
L'articolo non prevede la fornitura delle parti in legno.
The item does not include the supply of wooden parts

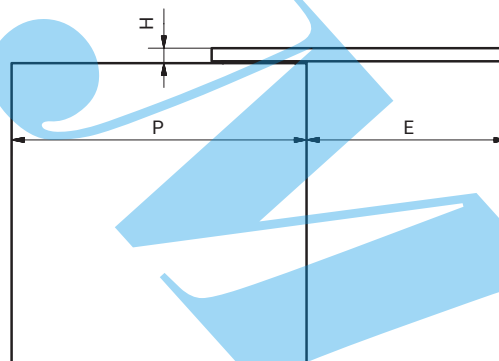
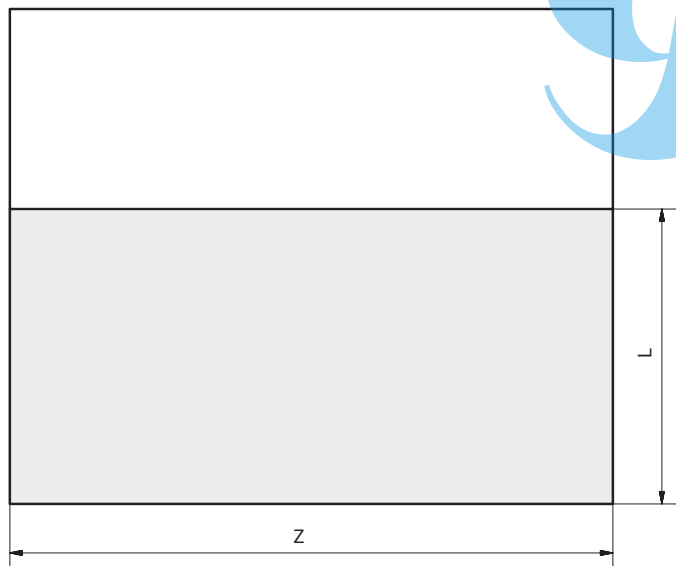

CODICE CODE	P	H MIN	Z MIN	L	S MIN	E
411/78.1270.22	900	45	1800	900	12	610
411/78.1271.22	1200	45	1800	1200	12	710

Valori espressi in millimetri. Value expressed in millimetres.

Legenda tabella a pagina 112. Table key on page 112.



Voilà / Voilà Flag

PIANO ESTRAIBILE CON GAMBE
PULL-OUT TOP TABLE WITH LEGS

DESIGN
ATIM R&S / ATIM R&D

FINITURA FINISHING

Inox bronzino

PORTATA LOAD CAPACITY

100 Kg equamente distribuiti
100 Kg evenly distributed

PACKAGING

105x87x14
13,5
0,13 m³

SCORRIMENTO SLIDING

Alluminio / Alluminio
Aluminium / Aluminium

OPTIONAL

su richiesta on request

KIT TAPPI KIT CAPS

2.9247311.XX

CERNIERE HINGES

2.8016912.06
2.8029912.12
2.8048168.06



NOTE
L'articolo non prevede la fornitura delle parti in legno.
The item does not include the supply of wooden parts

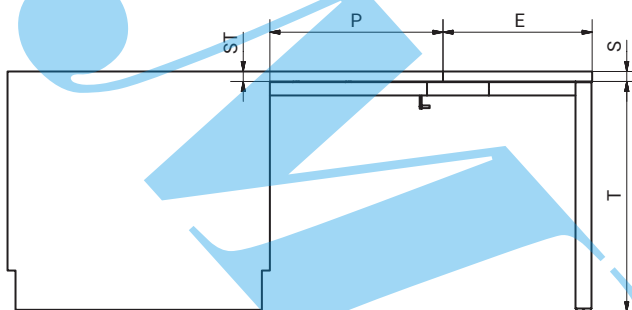
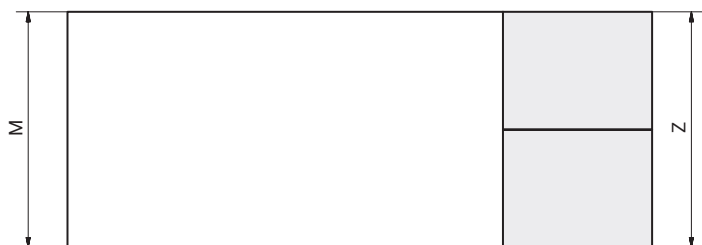

Voilà

CODICE CODE	M	P MIN	E	Z	S	ST	T	GAMBA LEG	SILENT
411/78.1190.25	900	660	570	900	20/40	20/40	865/890	60X60	78.1190.25
411/78.1194.25	800	660	570	800	20/40	20/40	865/890	60X60	78.1194.25
411/78.1195.25	955	660	570	955	20/40	20/40	865/890	60X60	78.1195.25

Valori espressi in millimetri. Value expressed in millimetres.

Legenda tabella a pagina 112. Table key on page 112.

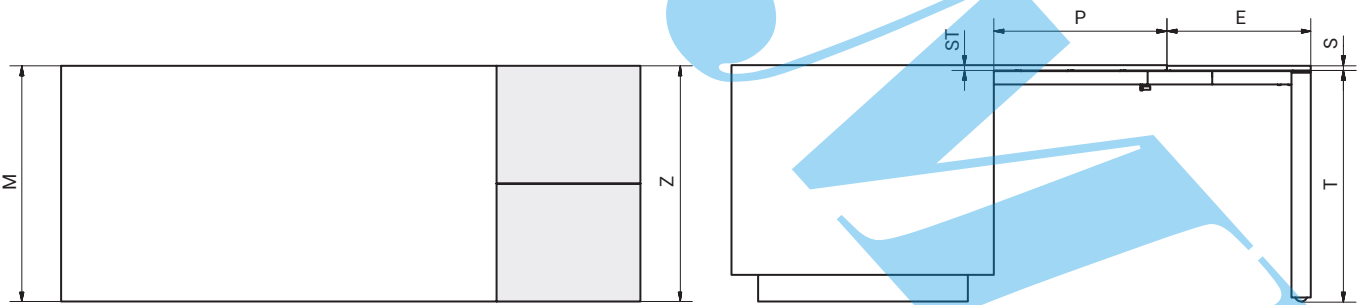

Voilà Flag

CODICE CODE	M	P MIN	E	Z	S	ST	T	GAMBA LEG	SILENT
411/78.1197.25	900	660	550	900	20	20	865/890	72X45	78.1197.25
411/78.1198.25	900	660	550	900	40	40	865/890	72X45	78.1198.25

Valori espressi in millimetri. Value expressed in millimetres.

Legenda tabella a pagina 112. Table key on page 112.

Voilà Chair

PIANO ESTRAIBILE CON GAMBE
PULL-OUT TOP TABLE WITH LEGS

DESIGN
ATIM R&S / ATIM R&D

FINITURA FINISHING

Inox Bronzino

PORTATA LOAD CAPACITY

100 Kg equamente distribuiti
100 Kg evenly distributed

PACKAGING

(2 packages)
95x85x10 cm 5 Kg 0,6 m³
80x20x10 cm 5 Kg 0,016 m³

SCORRIMENTO SLIDING

Alluminio / Alluminio
Aluminium / Aluminium

OPTIONAL

su richiesta on request

KIT TAPPI KIT CAPS

2.9247311.XX

CERNIERE HINGES

2.8016912.06
2.8029912.12
2.8048168.06

NOTE
L'articolo non prevede la fornitura delle parti in legno.
The item does not include the supply of wooden parts.

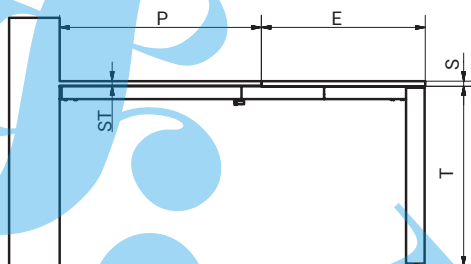
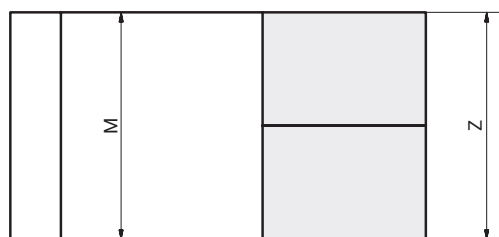

CODICE CODE	M	P MIN	E	Z	S	ST	T	GAMBA LEG	SILENT
411/78.1330.25	700	800	650	700	18/20	18/20	710/735	72X45	78.1330.25
411/78.1331.25	700	900	650	700	18/20	18/20	710/735	72X45	78.1331.25
411/78.1332.25	700	1000	650	700	18/20	18/20	710/735	72X45	78.1332.25
411/78.1333.25	800	800	650	800	18/20	18/20	710/735	72X45	78.1333.25
411/78.1334.25	800	900	650	800	18/20	18/20	710/735	72X45	78.1334.25
411/78.1335.25	800	1000	650	800	18/20	18/20	710/735	72X45	78.1335.25
411/78.1336.25	900	800	650	900	18/20	18/20	710/735	72X45	78.1336.25
411/78.1337.25	900	900	650	900	18/20	18/20	710/735	72X45	78.1337.25
411/78.1338.25	900	1000	650	900	18/20	18/20	710/735	72X45	78.1338.25

Valori espressi in millimetri. Value expressed in millimetres.

Legenda tabella a pagina 112. Table key on page 112.



Voilà Chair Reverse

DESIGN
ATIM R&S / ATIM R&D

PIANO ESTRAIBILE CON GAMBE
PULL-OUT TOP TABLE WITH LEGS

FINITURA FINISHING

Inox Bronzino

PORTATA LOAD CAPACITY

100 Kg equamente distribuiti
100 Kg evenly distributed

PACKAGING

(2 packages)
95x85x10 cm 5 Kg 0,6 m³
80x20x10 cm 5 Kg 0,016 m³

SCORRIMENTO SLIDING

Alluminio / Alluminio
Aluminium / Aluminium

OPTIONAL

su richiesta on request

KIT TAPPI KIT CAPS

2.9247311.XX

CERNIERE HINGES

2.8016912.06
2.8029912.12
2.8048168.06



NOTE
L'articolo non prevede la fornitura delle parti in legno
The item does not include the supply of wooden parts.

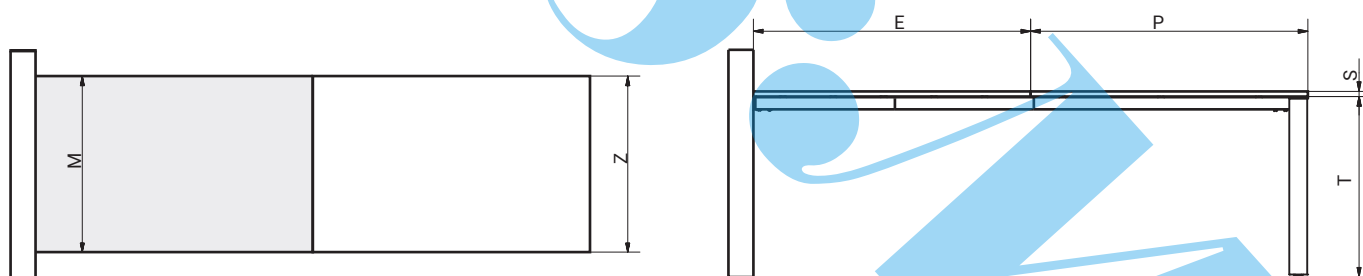

CODICE CODE	M	P	Z	S	ST	E MAX	T	GAMBA LEG	SILENT
411/78.1320.25	700	1100	700	18	18	1100	710/735	72X45	78.1320.25
411/78.1321.25	700	1300	700	18	18	1300	710/735	72X45	78.1321.25
411/78.1322.25	800	1100	800	18	18	1100	710/735	72X45	78.1322.25
411/78.1323.25	800	1300	800	18	18	1300	710/735	72X45	78.1323.25
411/78.1324.25	900	1100	900	18	18	1100	710/735	72X45	78.1324.25
411/78.1325.25	900	1300	900	18	18	1300	710/735	72X45	78.1325.25

Valori espressi in millimetri. Value expressed in millimetres.

Legenda tabella a pagina 112. Table key on page 112.



Dinamico / Dinamico+

PIANO SCORREVOLE
SLIDING TABLE TOP

FINITURA FINISHING

Inox bronzino

PORTATA

LOAD CAPACITY

100 Kg equamente distribuiti
100 Kg evenly distributed

PACKAGING

Meccanismo

Mechanism:

42x18x6 8 Kg 0,005 m³

Gola

4300 mm 3,8 Kg 1 m³

SCORRIMENTO SLIDING

Dinamico

Cuscinetti a sfera
Ball-bearing slide system

Dinamico+

Alluminio / Alluminio

+ Cuscinetti a sfera

+ Ruote a pavimento

Aluminium / Aluminium

+ Ball-bearing slide system

+ Floor wheels

DESIGN

ATIM R&S / ATIM R&D

OPTIONAL

su richiesta on request

KIT TAPPI

KIT CAPS

2.9247311.XX

CERNIERE

HINGES

2.8016912.06

2.8029912.12

2.8048168.06

NOTE

L'articolo non prevede la fornitura delle parti in legno.
L'articolo viene venduto con gola in barra 4300 mm.
The item does not include the supply of wooden parts.
The item is sold with a 4300 mm rod.

Gola

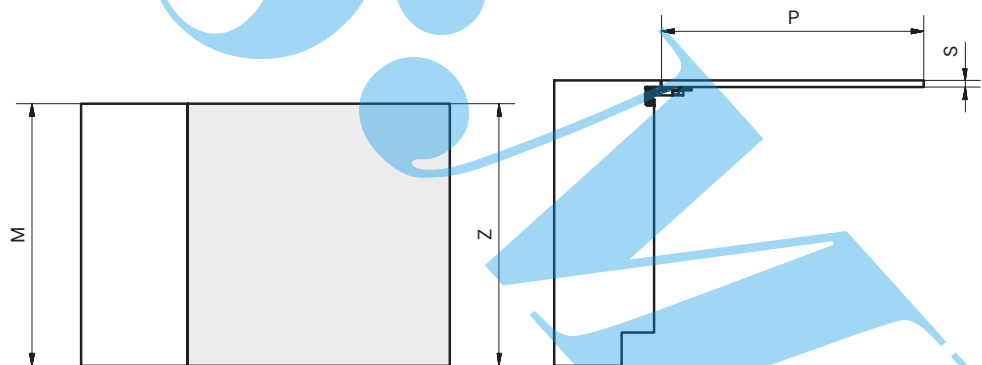
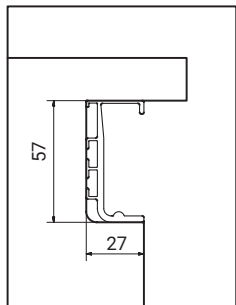

Dinamico

PROFILO GOLA + STAFFE

GOLA PROFILE + CARTS

CODICE CODE	M MIN	P MIN	Z MIN	S MIN
411/78.1301.25	500	500	500	20

Valori espressi in millimetri. Value expressed in millimetres.

Legenda tabella a pagina 112. Table key on page 112.

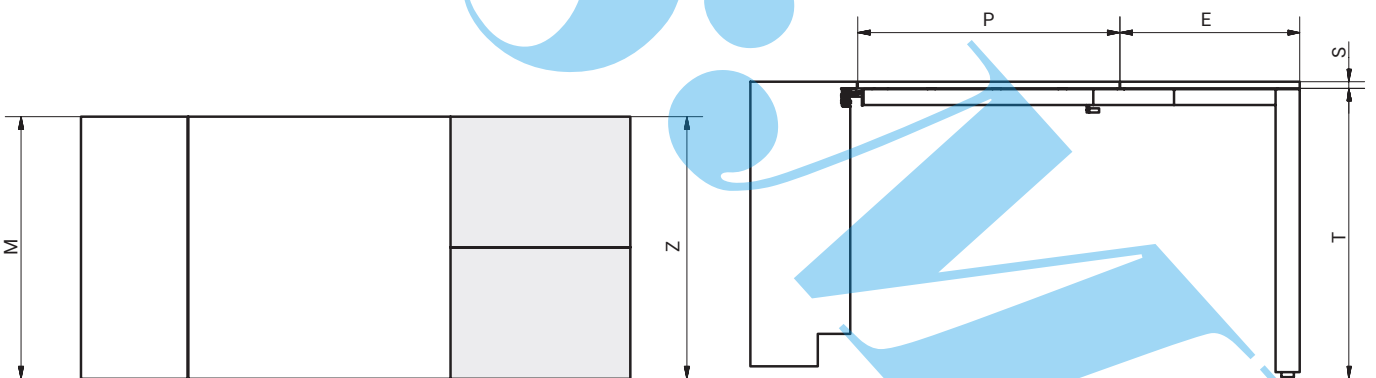

Dinamico+

PROFILO GOLA+STAFFE+MECCANISMO ALLUNGABILE+GAMBA
 GOLA PROFILE+CARTS+ EXTENDABLE MECHANISM+LEG)

CODICE CODE	M	P MIN	Z MIN	E	S	T	GAMBA LEG	SILENT
411/78.1192.25	800	800	800	570	20	865/890	72X45	78.1192.25
411/78.1193.25	800	800	800	570	40	865/890	72X45	78.1193.25

Valori espressi in millimetri. Value expressed in millimetres.

Legenda tabella a pagina 112. Table key on page 112.

Sestante

PIANO SCORREVOLE E GIREVOLE
SU TOP CON GAMBE
SLIDING AND REVOLVING
TABLE TOP WITH LEGS

FINITURA FINISHING

Anodizzato naturale/ Anodised aluminium
(Guide/Slides)

RAL 9005 Nero/Black
(Gamba/Leg)

PORTATA LOAD CAPACITY

80 Kg equamente distribuiti
80 Kg evenly distributed

PACKAGING

160XØ7 2.5 Kg 0,006 m³
100x100x25 10 Kg 0,25 m³

SCORRIMENTO SLIDING

Cuscinetti a sfera
Ball-bearing slide system

NOTE
411/78.129X.22
Articolo fornito senza gamba
Item supplied without leg*
I codici con R sono forniti con gamba regolabile
Items with R are supplied with adjustable leg*

L'articolo non prevede la fornitura delle parti in legno
The item does not include the supply of wooden parts.

DESIGN

Arch. Giulio Manzoni
ATIM R&S / ATIM R&D

> L'ARTICOLO È COPERTO DA BREVETTO
THE ITEM IS PATENT PROTECTED

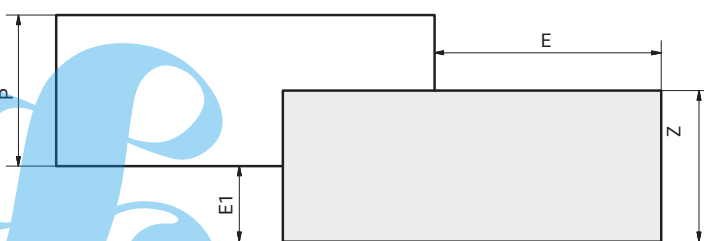
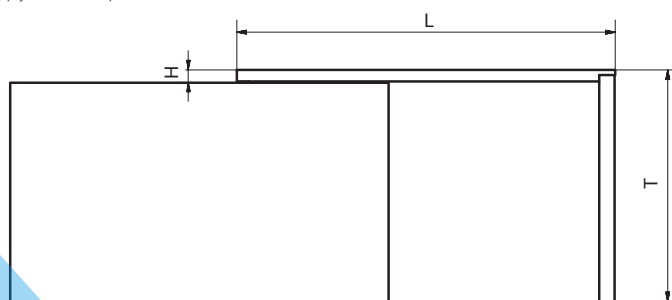

CODICE / CODE	P	L	T	H	E	E1	Z	S MIN
411/78.129X.22	-	1500	-	55	900	300	-	18
411/78.1290.22	600	1500	930	55	900	300	600	18
411/78.1291.22	700	1500	930	55	900	300	700	18
411/78.1292.22	800	1500	930	55	900	300	800	18
411/78.1293.22	900	1500	930	55	900	300	900	18
411/78.1293.22	1200	1500	930	55	900	300	1200	18
411/78.1290.22R	600	1500	800/960	55	900	300	600	18
411/78.1291.22R	700	1500	800/960	55	900	300	700	18
411/78.1292.22R	800	1500	800/960	55	900	300	800	18
411/78.1293.22R	900	1500	800/960	55	900	300	900	18
411/78.1293.22R	1200	1500	800/960	55	900	300	1200	18

Valori espressi in millimetri. Value expressed in millimetres.

Legenda tabella a pagina 112. Table key on page 112.



Evolution +39 / Evolution XL +39

TAVOLO DA CABINET ESTRAIBILE CON GAMBA A PONTE
PULL-OUT CABINET TABLE WITH BRIDGE LEG

FINITURA FINISHING

Inox bronzino
Guide/Slides

Grigio /Grey Ral 7012
Gamba/Leg

VERSIONE NAKED (N) NAKED VERSION (N)

Gamba
Nero opaco RAL 9005.
Senza traversi per fissaggio anta
Leg
Matt black RAL 9005.
Without bar for door fixing

PORTATA LOAD CAPACITY

100 Kg equamente distribuiti
100 Kg evenly distributed

SCORRIMENTO SLIDING

Alluminio / Alluminio
Aluminium / Aluminium

PACKAGING (2 packages)

Guide/Slides
118x18x8 cm
6 Kg
0,017 m³

Gamba/Leg
Evolution +39 600
Evolution XL +39 600
57x77x8 cm
8 Kg
0,035 m³

Evolution +39 900
Evolution +39 XL 900
87x88x8 cm
11 Kg
0,055 m³

Evolution +39 1200
Evolution XL +39 1200
117x88x8 cm
14 Kg
0,072 m³

DESIGN

Arch. Giulio Manzoni
ATIM R&S / ATIM R&D

OPTIONAL

su richiesta on request

KIT TAPPI

KIT CAPS

Evolution +39 2.9247241.XX
Evolution XL +39 2.9247271.XX

CERNIERE

HINGES

2.8016912.06
2.8029912.12
2.8048168.06

NOTE

L'articolo non prevede la fornitura delle parti in legno
The item does not include the supply of wooden parts.

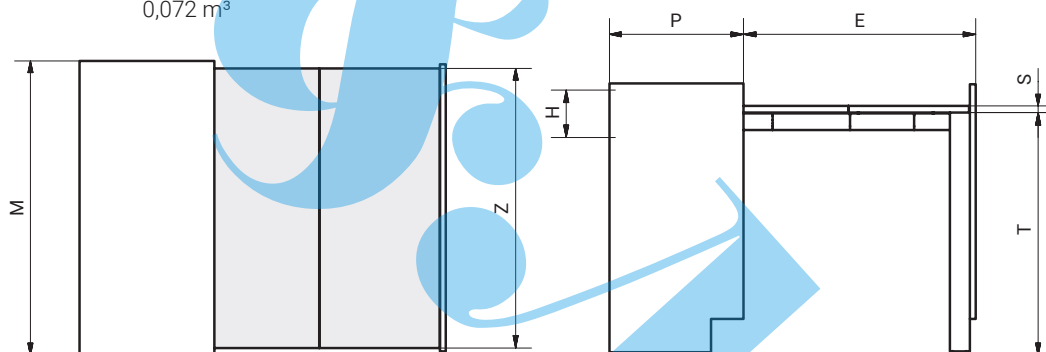

Evolution +39

CODICE CODE	M	P MIN	H MIN	S1	E	S MIN	Z MIN	T	SILENT
411/39.1610.25	600	390	120	15/20	690	16	555	730/755	39.1610.25
411/39.1611.25	900	390	120	15/20	690	16	855	730/755	39.1611.25
411/39.1612.25	1200	390	120	15/20	690	16	1155	730/755	39.1612.25
411/78.1610.25N	600	520	120	15/20	1040	555	16	730/755	78.1610.25N
411/78.1611.25N	900	520	120	15/20	1040	855	16	730/755	78.1611.25N
411/78.1612.25N	1200	520	120	15/20	1040	1155	16	730/755	78.1612.25N

Valori espressi in millimetri. Value expressed in millimetres.

Legenda tabella a pagina 112. Table key on page 112.

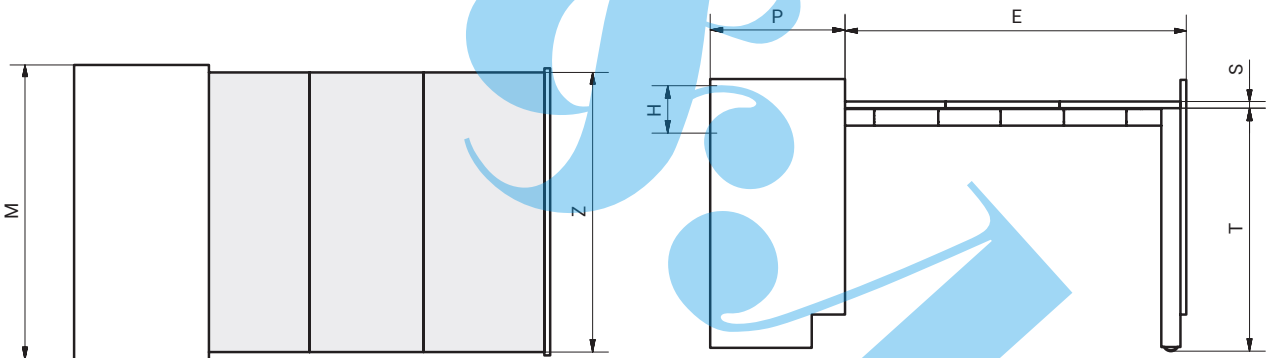

Evolution XL +39

CODICE CODE	M	P MIN	H MIN	S1	E	S MIN	Z MIN	T	SILENT
411/39.1620.25	600	390	150	15/20	1025	16	555	730/755	39.1620.25
411/39.1621.25	900	390	150	15/20	1025	16	855	730/755	39.1621.25
411/39.1622.25	1200	390	150	15/20	1025	16	1155	730/755	39.1622.25
411/78.1620.25N	600	520	150	15/20	1520	555	16	730/755	78.1620.25N
411/78.1621.25N	900	520	150	15/20	1520	855	16	730/755	78.1621.25N
411/78.1622.25N	1200	520	150	15/20	1520	1155	16	730/755	78.1622.25N

Valori espressi in millimetri. Value expressed in millimetres.

Legenda tabella a pagina 112. Table key on page 112.

Homework +39

TAVOLO ABBATTIBILE A SOFFIETTO
FOLD-OUT TABLE

DESIGN

Arch. Giulio Manzoni
ATIM R&S / ATIM R&D

FINITURA FINISHING

Inox bronzino

PORTATA LOAD CAPACITY

40 Kg equamente distribuiti
40 Kg evenly distributed

PACKAGING

118x18x8 cm
5 Kg
0,017 m³

SCORRIMENTO SLIDING

Alluminio / Alluminio
Aluminium / Aluminium

OPTIONAL

su richiesta on request

KIT TAPPI KIT CAPS

2.9247251.XX

KIT HOMEWORK

Cerniere
Hinges
+ Blumotion

2.9248320.XX

NOTE

L'articolo non prevede la fornitura delle parti in legno
The item does not include the supply of wooden parts.

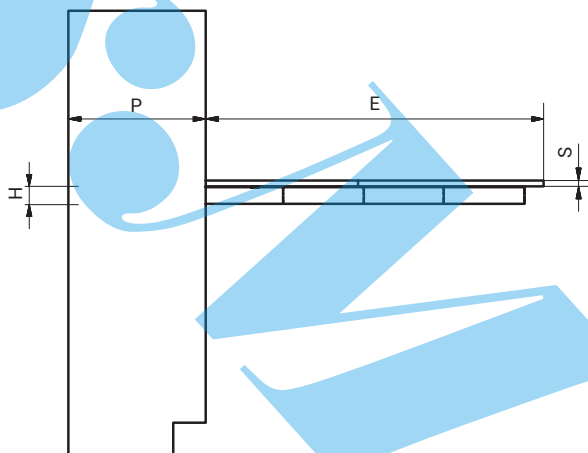

CODICE CODE	M	P MIN	H	S1	E	Z MIN	S MIN	SILENT
411/39.1200.25	600	390	54	15/20	1015	555	16	39.1200.25
411/39.1210.25	900	390	54	15/20	1015	855	16	39.1210.25
411/39.1220.25	1200	390	54	15/20	1015	1155	16	39.1220.25

Valori espressi in millimetri. Value expressed in millimetres.

Legenda tabella a pagina 112. Table key on page 112.



Lunch +39

TAVOLO DA CASSETTO ESTRAIBILE
PULL-OUT DRAWER TABLE

FINITURA FINISHING

Inox bronzino

PORTATA LOAD CAPACITY

60 Kg equamente distribuiti
60 Kg evenly distributed

PACKAGING

118x18x8 cm
3,5 Kg
0,017 m³

SCORRIMENTO SLIDING

Alluminio / Alluminio
Aluminium / Aluminium

OPTIONAL

su richiesta on request

KIT TAPPI KIT CAPS

2.9247231.XX

CERNIERE HINGES

2.8016912.06
2.8029912.12
2.8048168.06

DESIGN

Arch. Giulio Manzoni
ATIM R&S / ATIM R&D



NOTE
L'articolo non prevede la fornitura delle parti in legno
The item does not include the supply of wooden parts.

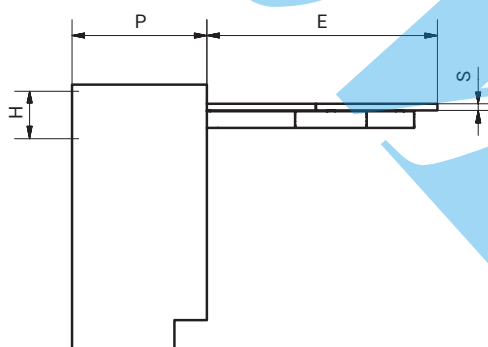
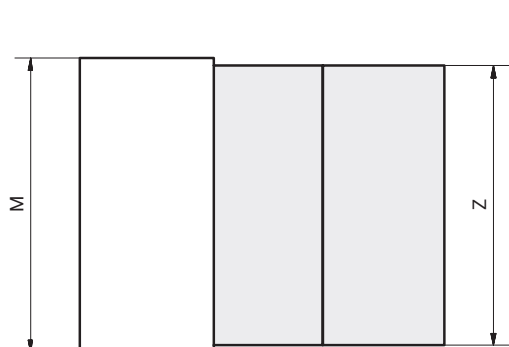

CODICE CODE	M	P MIN	H MIN	S1	E	Z MIN	S MIN	SILENT
411/39.1100.25	450/1200	390	120	15/20	705	405/1155	16	39.1100.25

Valori espressi in millimetri. Value expressed in millimetres.

Legenda tabella a pagina 112. Table key on page 112.



Mensola T-Able +39

TAVOLO DA CASSETTO ESTRAIBILE CON GAMBA SINGOLA
 ABBATTIBILE TELESCOPICA
 PULL-OUT DRAWER TABLE WITH SINGLE
 TELESCOPIC FOLDING LEG

FINITURA FINISHING

Inox Bronzino

PORTATA LOAD CAPACITY

100 Kg equamente distribuiti
 100 Kg evenly distributed

PACKAGING

124x16x7 cm
 8 Kg
 0,14 m³

SCORRIMENTO SLIDING

Alluminio / Alluminio
 Aluminium / Aluminium

OPTIONAL

su richiesta on request

KIT TAPPI KIT CAPS

2.9247261.XX

DESIGN

Arch. Giulio Manzoni
 ATIM R&S / ATIM R&D



NOTE
 L'articolo non prevede la fornitura delle parti in legno.
 The item does not include the supply of wooden parts.

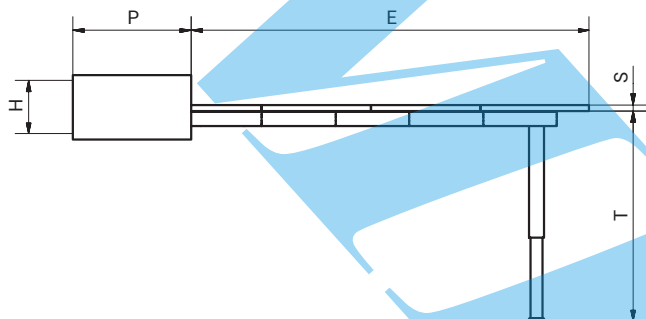
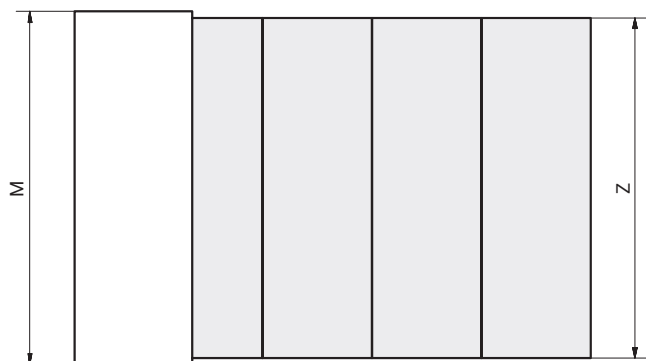

CODICE CODE	M	P MIN.	H MIN	S1	E	Z MIN	S MIN	T	SILENT
411/39.1920.25X	1200	390	180	15/20	1350	1155	14	712/737	39.1920.25X

Valori espressi in millimetri. Value expressed in millimetres.

Legenda tabella a pagina 112. Table key on page 112.



Oplà +39

PIANO ESTRAIBILE FILO RIPIANO
PULL-OUT TOP FLUSH WITH SHELF

FINITURA FINISHING

Inox Bronzino

PORTATA LOAD CAPACITY

40 Kg equamente distribuiti
40 Kg evenly distributed

PACKAGING

118x18x8 cm
3 Kg
0,017 m³

SCORRIMENTO SLIDING

Alluminio / Alluminio
Aluminium / Aluminium

OPTIONAL

su richiesta on request

KIT TAPPI KIT CAPS

2.9247221.XX

DESIGN

Arch. Giulio Manzoni
ATIM R&S / ATIM R&D

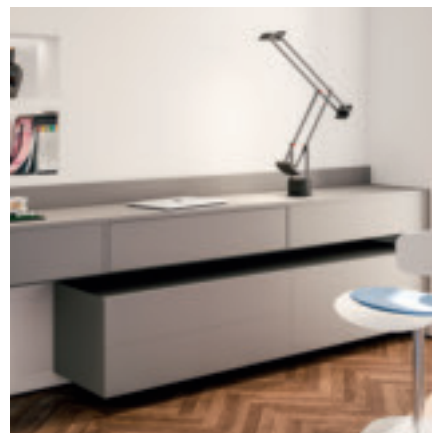

NOTE
L'articolo non prevede la fornitura delle parti in legno
The item does not include the supply of wooden parts.

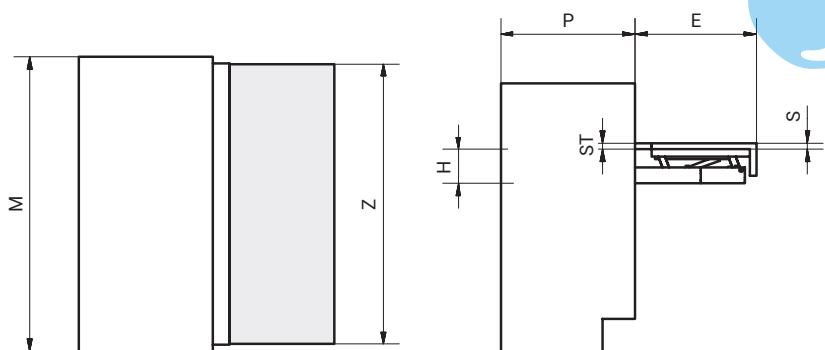

CODICE CODE	M	P MIN	H MIN	S1	E	S	ST	Z	SILENT
411/39.1700.25	450/1000	390	100	15/20	370	18/22	18/22	405/955	39.1700.25
411/39.1720.25	1200	390	100	15/20	370	18/22	18/22	1155	39.1720.25

Valori espressi in millimetri. Value expressed in millimetres.

Legenda tabella a pagina 112. Table key on page 112.



Oplà Folding +39

PIANO ESTRAIBILE FILO RIPIANO
PULL-OUT TOP FLUSH WITH SHELF

FINITURA FINISHING

Inox Bronzino

PORTATA LOAD CAPACITY

40 Kg equamente distribuiti
40 Kg evenly distributed

PACKAGING

118x18x8 cm
3 Kg
0,017 m³

SCORRIMENTO SLIDING

Alluminio / Alluminio
Aluminium / Aluminium

OPTIONAL

su richiesta on request

KIT TAPPI KIT CAPS

2.9247221.XX

DESIGN

Arch. Giulio Manzoni
ATIM R&S / ATIM R&D

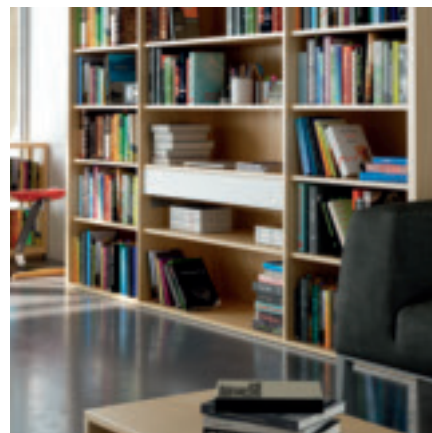

NOTE
L'articolo non prevede la fornitura delle parti in legno
The item does not include the supply of wooden parts.

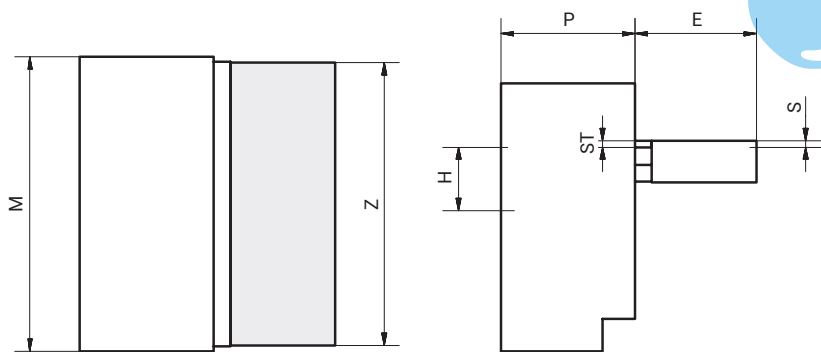

CODICE CODE	M	P MIN.	H MIN	S1	E	Z	S	ST	SILENT
411/39.1700.25 F	450/1000	390	205	15/20	370	405/955	16/25	16/25	39.1700.25 F
411/39.1720.25 F	1200	390	205	15/20	370	1155	16/25	16/25	39.1720.25 F

Valori espressi in millimetri. Value expressed in millimetres.

Legenda tabella a pagina 112. Table key on page 112.



T-Bench +39

SEDUTA DA CASSETTO ESTRAIBILE
CON GAMBA SINGOLA ABBATTIBILE
PULL-OUT DRAWER BENCH
WITH SINGLE FOLDING LEG

FINITURA FINISHING

Inox Bronzino

PORTATA LOAD CAPACITY

100 Kg equamente distribuiti
100 Kg evenly distributed

PACKAGING

118x18x8 cm
5 Kg
0,017 m³

SCORRIMENTO SLIDING

Alluminio / Alluminio
Aluminium / Aluminium

OPTIONAL

su richiesta on request

KIT TAPPI KIT CAPS

2.9247231.XX

CERNIERE HINGES

2.8016912.06
2.8029912.12
2.8048168.06

NOTE

L'articolo non prevede la fornitura delle parti in legno
The item does not include the supply of wooden parts.

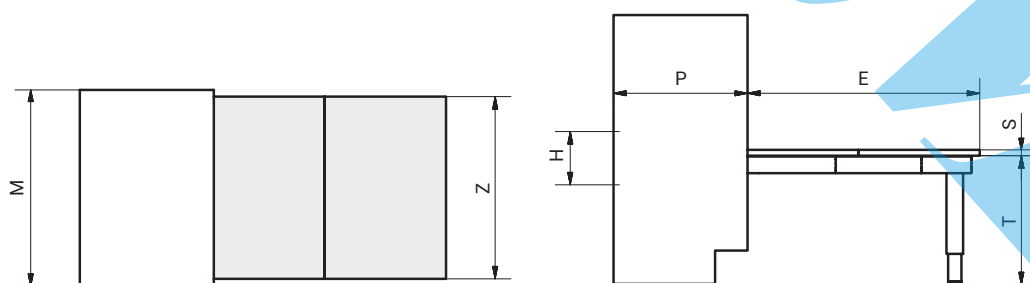

CODICE CODE	M	P MIN.	H MIN	S1	E	S MIN	Z MIN	T	SILENT
411/39.1950.25	450	390	120	15/20	705	16	405	395/420	39.1950.25
411/39.1960.25	600	390	120	15/20	705	16	555	395/420	39.1960.25

Valori espressi in millimetri. Value expressed in millimetres.

Legenda tabella a pagina 112. Table key on page 112.



Shot+39

PIANO DA CASSETTO ESTRAIBILE
PULL-OUT DRAWER WORKTOP

DESIGN

Arch. Giulio Manzoni
ATIM R&S / ATIM R&D

FINITURA FINISHING

Inox Bronzino

PORTATA LOAD CAPACITY

80 Kg equamente distribuiti
80 Kg evenly distributed

PACKAGING

118x18x8 cm
4 Kg
0,017 m³

SCORRIMENTO SLIDING

Alluminio / Alluminio
Aluminium / Aluminium

OPTIONAL

su richiesta on request

KIT TAPPI KIT CAPS

2.9247221.XX

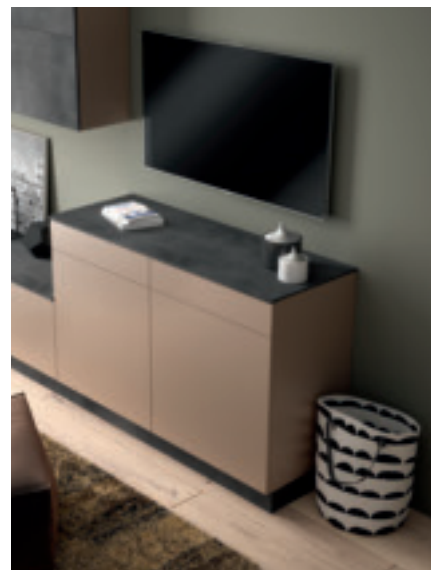

NOTE
L'articolo non prevede la fornitura delle parti in legno.
The item does not include the supply of wooden parts.

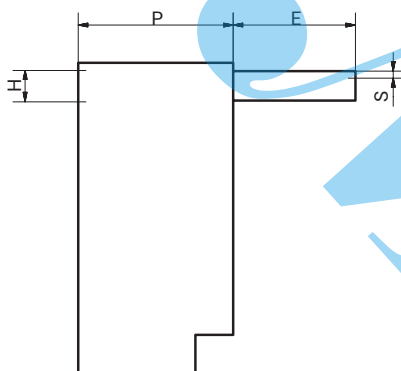
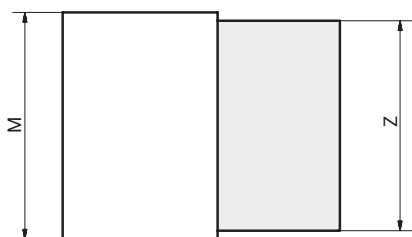

CODICE CODE	M MIN	P MIN	H MIN	S1	E	Z MIN	S MIN	SILENT
411/39.1130.25	450	390	90	15/20	325	405	16	39.1130.25
411/39.1130.25 F	450	390	90	15/20	325	405	16	39.1130.25 F

Valori espressi in millimetri. Value expressed in millimetres.

Legenda tabella a pagina 112. Table key on page 112.



Prua

ASSE DA STIRO ESTRAIBILE
PULL-OUT IRONING BOARD

FINITURA FINISHING

Inox Bronzino

PORTATA LOAD CAPACITY

80 Kg equamente distribuiti
80 Kg evenly distributed

PACKAGING

Prua
60x36x12 cm
7,5 Kg
0,25 m³

SCORRIMENTO SLIDING

Alluminio / Alluminio
Aluminium / Aluminium

PIANO TOP

Multistrato in betulla fenolico
Phenolic birch plywood

OPTIONAL

su richiesta on request

KIT TAPPI KIT CAPS

2.9247241.XX

PANNO DI RICAMBIO SPARE CLOTH

2.6535460.13

DESIGN

Arch. Giulio Manzoni
ATIM R&S / ATIM R&D



NOTE
Articolo fornito di piano con tessuto grigio.
Item supplied top with gray cloth.

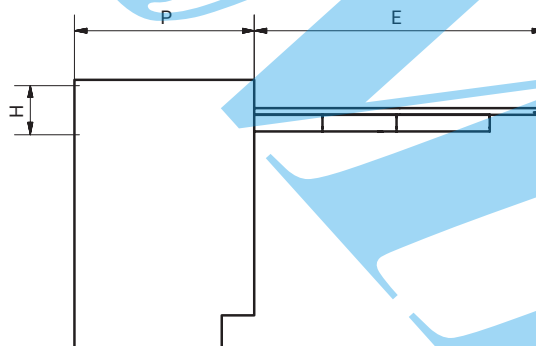
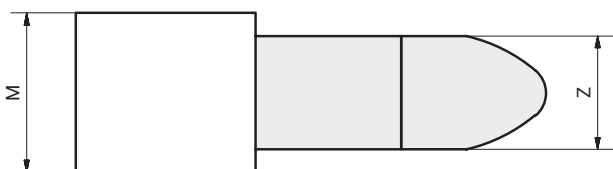

Prua

CODICE CODE	M MIN	P MIN	H MIN	E	Z	SILENT
411/78.1180.22	360	535	150	885	350	78.1180.22

Valori espressi in millimetri. Value expressed in millimetres.

Legenda tabella a pagina 112. Table key on page 112.

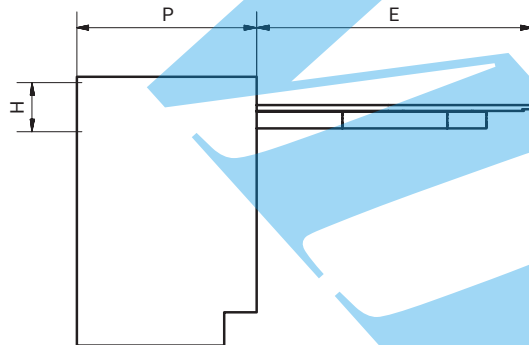
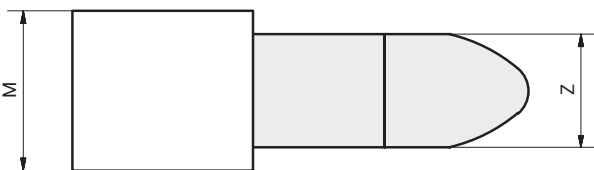

Prua Short

CODICE CODE	M MIN	P MIN	H MIN.	E	Z	SILENT
411/78.1181.22	330	450	140	840	350	78.1181.22

Valori espressi in millimetri. Value expressed in millimetres.

Legenda tabella a pagina 112. Table key on page 112.

Prua Lift

ASSE DA STIRO A RIBALTA
TILTING IRONING BOARD

DESIGN
ATIM R&S / ATIM R&D

FINITURA FINISHING

Inox Bronzino

PORTATA LOAD CAPACITY

50 Kg equamente distribuiti
50 Kg evenly distributed

PACKAGING

120x30x10 cm
4 Kg
0,036 m³

PIANO TOP

Multistrato in betulla fenolico
Phenolic birch plywood

OPTIONAL

su richiesta on request

PANNO DI RICAMBIO SPARE CLOTH

Prua Lift 350 2.6551940.13

Prua Lift 450 2.6552110.13



NOTE
Articolo fornito di piano con tessuto grigio
Item supplied top with gray cloth

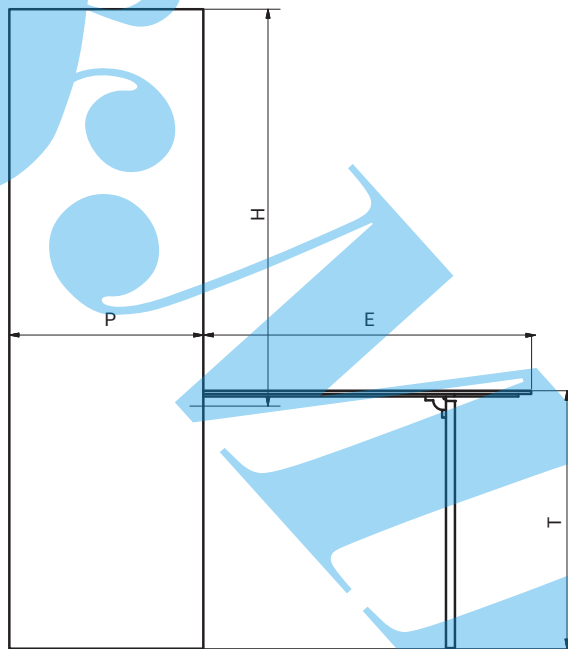
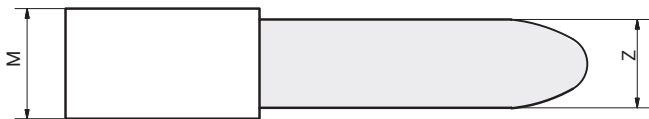

CODICE CODE	M	P MIN	H MIN	S1	E	Z	T
411/78.1186.22	350	100	1100	15/20	1050	280	820
411/78.1187.22	450	100	1100	15/20	1050	380	820

Valori espressi in millimetri. Value expressed in millimetres.

Legenda tabella a pagina 112. Table key on page 112.



Prua Swing

ASSE DA STIRO ROTANTE
REVOLVING PULL-OUT IRONING BOARD

DESIGN
ATIM R&S / ATIM R&D

FINITURA FINISHING

Inox bronzino

PORTATA LOAD CAPACITY

40 Kg equamente distribuiti
40 Kg evenly distributed

PACKAGING

100x40x6 cm
5 Kg
0,025 m³

ROTAZIONE REVOLVING

Piastra in ferro zincato
Galvanized iron plate

PIANO TOP

Multistrato in betulla fenolico
Phenolic birch plywood

OPTIONAL

su richiesta on request

PANNO DI RICAMBIO SPARE CLOTH

2.6535460.13

NOTE
Articolo fornito di piano con tessuto grigio
Item supplied top with gray cloth

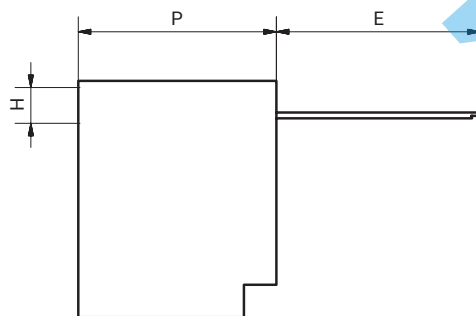
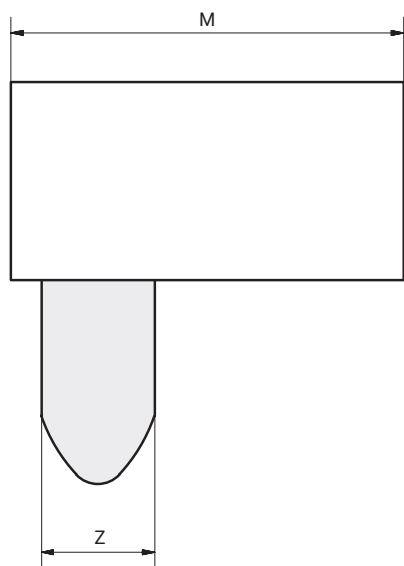

CODICE CODE	M	P MIN	H MIN	Z	E
411/78.1182.02	1200	450	90	350	620

Valori espressi in millimetri. Value expressed in millimetres.

Legenda tabella a pagina 112. Table key on page 112.



Basket

SACCO LAVANDERIA CON PIANO ESTRAIBILE
PULL-OUT LAUNDRY BAG WITH TOP

DESIGN

Arch. Giulio Manzoni
ATIM R&S / ATIM R&D

FINITURA FINISHING

Inox bronzino

PORTATA LOAD CAPACITY

40 Kg equamente distribuiti
40 Kg evenly distributed

PACKAGING

118x18x8 cm
4 Kg
0,017 m³

SCORRIMENTO SLIDING

Alluminio / Alluminio
Aluminium / Aluminium

OPTIONAL

su richiesta on request

KIT TAPPI KIT CAPS

2.9249311.XX

CERNIERE HINGES

2.8016912.06
2.8029912.12
2.8048168.06

NOTE

L'articolo non prevede la fornitura delle parti in legno.
L'articolo è fornito con sacco in tessuto.
The item does not include the supply of wooden parts.
The item supplied with fabric bag.

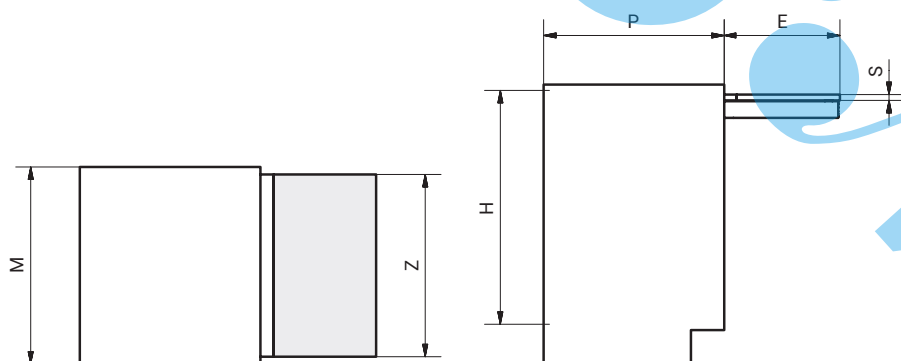

CODICE CODE	M	P MIN	H MIN	S1	E	Z	S MIN	SILENT
411/78.1183.25	450	450	690	15/20	350	405	16	78.1183.25
411/78.1184.25	600	450	690	15/20	350	555	16	78.1184.25
411/78.1185.25	900	450	690	15/20	350	855	16	78.1185.25

Valori espressi in millimetri. Value expressed in millimetres.

Legenda tabella a pagina 112. Table key on page 112.



DIRECTORY



M	LARGHEZZA	WIDTH
P	PROFONDITÀ	DEPTH
H	ALTEZZA	HEIGHT
S1	SPESSORE SPALLA	SIDE THICKNESS
E	APERTURA PIANO	TOP OPENING
Z	LARGHEZZA PIANO	TOP WIDTH
S	SPESSORE PIANO	TOP THICKNESS
ST	SPESSORE TOP	COUNTERTOP THICKNESS
T	ALTEZZA MECCANISMO	HEIGHT MECHANISM
L	LARGHEZZA MECCANISMO	WIDTH MECHANISM

Le riproduzioni fotografiche sono puramente indicative e non danno luogo ad alcun vincolo contrattuale.
L'azienda si riserva di modificare le caratteristiche dimensionali e tecniche dei prodotti in qualsiasi momento e senza l'obbligo di alcun preavviso.
La riproduzione, anche parziale, è vietata a norma di legge.

The photographic reproductions are purely indicative and they do not contractual obligations.
The company reserves the right in any time to modify technical notes and measures of the products, if necessary, without notice.
All partial or total reproduction is strictly forbidden. All right reserved.

REFERENCES

COMPOSIT

db
GROUP

giessig

HÄFELE

LMC

LINCOLN
SENTRY

cuisinella
A l'écoute de vos envies

STOSA
CUCINE

Poliform

Hevolus
EVOLUZIONE CUCINE

ARREX
LE CUCINE

Richelieu

Gicinque
cucine

SCHMIDT
Le sur-mesure n'est plus un luxe

MERCANTINI MOBILI
CUCINE, BOUTE D'ARRIARIERE

LUBE
CUCINE

SUGATSUNE

Dada

RIFLESSI
DESIGNED AND MADE IN ITALY

ANGELINI
PROFESSIONAL

FAER
AMBIENTI
GRUPPO LUBE

PEDINI

Veneta Cucine

Binova

MOBILTURI
EVOLUZIONE CUCINA

A
ASTOR MOBILI

dibiesse
CUCINE

COLOMBINI GROUP
COLOMBINI CASA febalcasa ROSSANA

Euromobil

Arredo3
CUCINE

clei
il fascino dell'ingresso

Boffi

joli
designed to last

TRANSFORMAZIONE

MESE

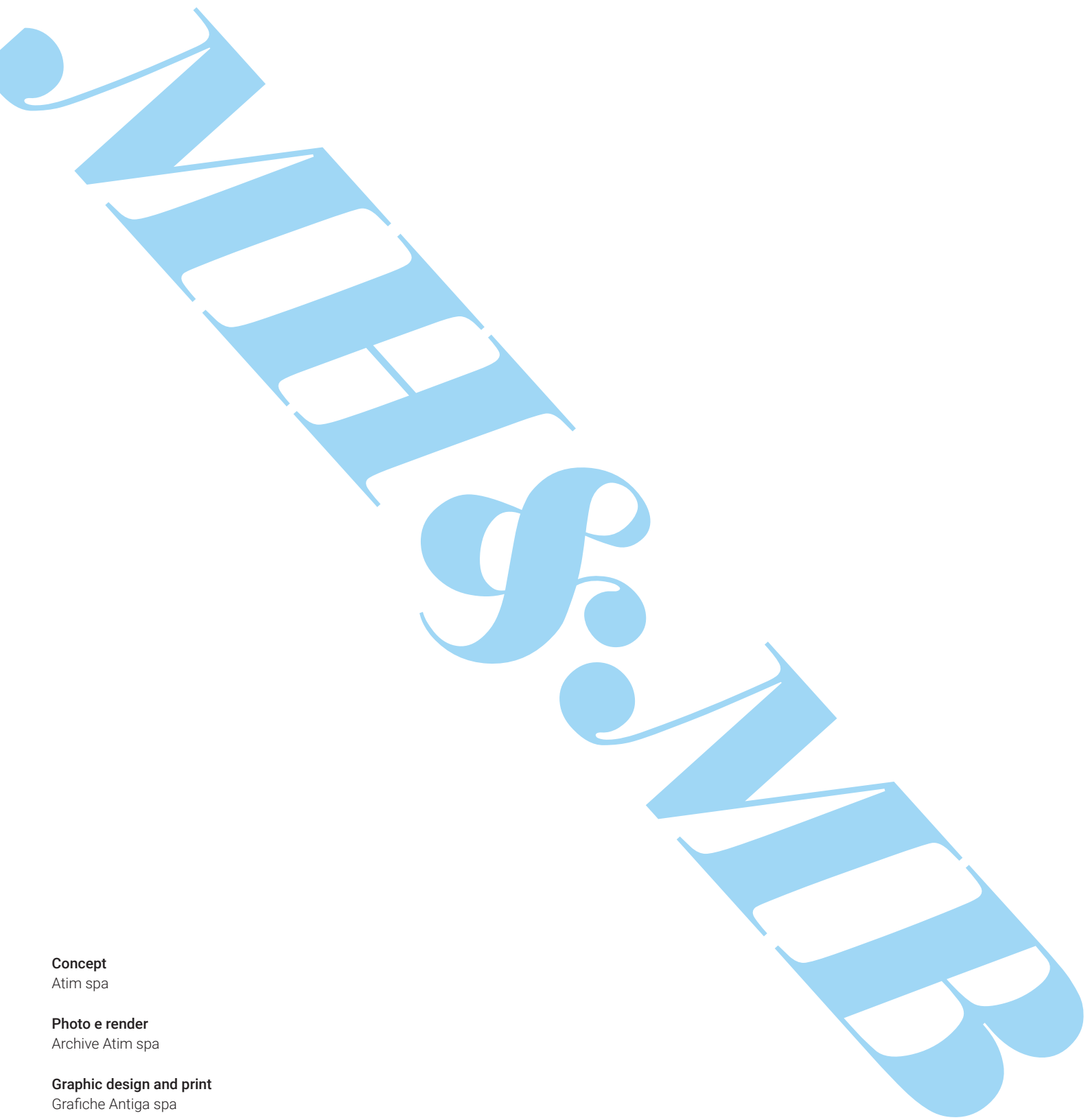

Concept
Atim spa

Photo e render
Archive Atim spa

Graphic design and print
Grafiche Antiga spa

9.2019

KESSIE



Atim spa

Uffici
Produzione
Showroom

Via IV Novembre, 52
20019 Settimo Milanese
Milano - Italy

Tel. +39 02 33503203
Fax +39 02 33516514

info@atimspa.com
atimspa.com